

**20
21**

CATALOG



INDEX

NEW PRODUCTS	8
NON SERIES	80
ACCESSORIES	84
DISCONTINUED PRODUCT	90

ROAD

COUGAR	14
TIMANIA	18
TUX	20
EXL	22
SLA	24
CLS	26
FALCON	30
ONE	34
OE	36

MTB

TIMANIA	44
TUX	46
EXL	48
SLA	50
CLS	52
LYNX	54
MST	58
ONE	60
OE	62

TRIATHLON

TIME ZONE	70
AERO-IMPEL	72
EXTENSION	74
BULL HORN	77



I'M IN
BETTER
CONTROL

WE ARE IN
BETTER
CONTROL

Since 1989 Controltech delivers only the best. We have an all around set for all your needs.

From MTB to Road to Triathlon, Controltech products are the perfect choice when you want to push the limits.

Controltech is for people who never live in their comfort zone.



ROAD CHART

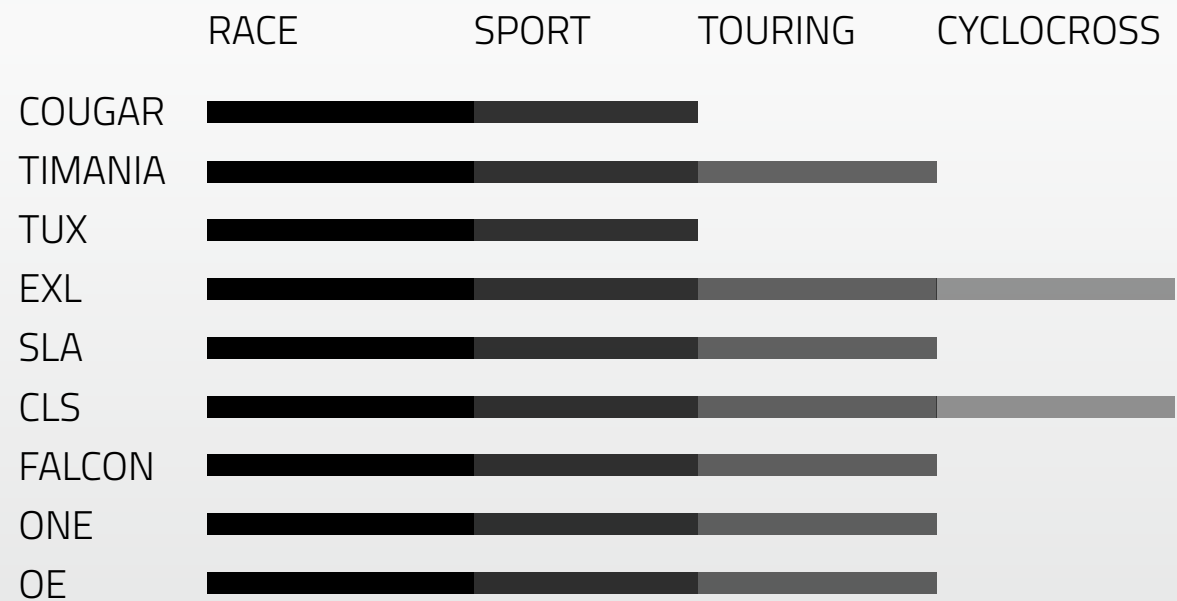

MTB CHART

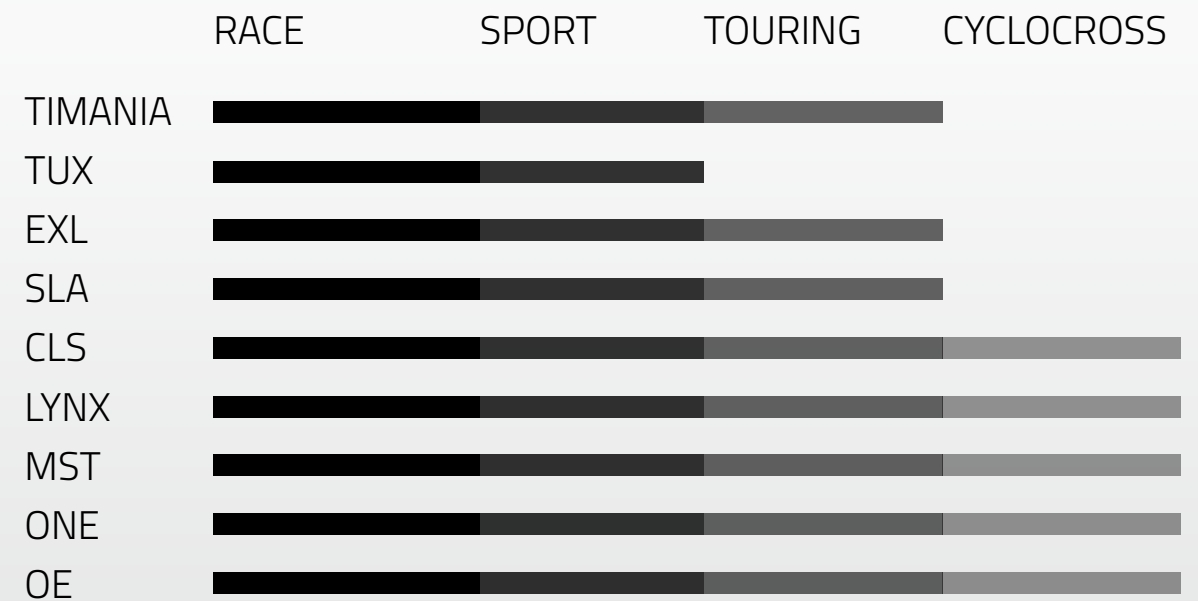

NEW

PRODUCTS

CARBON TRACK HANDLEBAR

RA-548
 MATERIAL: CARBON FIBER
 WIDTH: 340/350/360/380/400MM
 REACH: 110MM
 DROP: 149MM
 BARBORE Ø: 31.8MM
 GRIP DIAMETER: Ø26MM
 WEIGHT: 350G (360MM)



COUGAR AERO BASEBAR

RA-547
 MATERIAL: AL6061
 WIDTH: 400/420/440MM
 BARBORE Ø: 31.8MM
 WEIGHT: 319G (420MM)
 UCI COMPLIANT 3:1



LYNX 31.8 EI BAR

ATB-310DB68
 MATERIAL: AL6061
 BARBORE Ø: 31.8MM
 LENGTH: 750/800MM
 RISE: 35MM
 UP SWEEP: 4°
 BACK SWEEP: 9°
 WEIGHT: 306G (750MM)
 COLOR: RED/GRAY

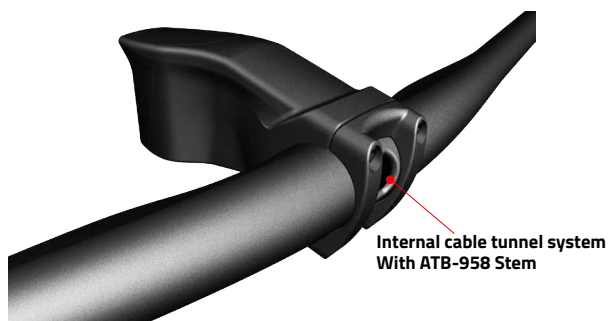

LYNX -10° DROP STEM

ATB-958
 MATERIAL: AL6061
 HANDLEBAR Ø: 31.8MM
 STEERER Ø: 28.6MM
 LENGTH: 60/70/80/90MM
 ANGLE: -10°
 WEIGHT: 210G (TBD)(70MM)
 COLOR: RED/GRAY

Internal cable tunnel system



-17° DROP STEM

ATB-960
 MATERIAL: AL6061
 HANDLEBAR Ø: 31.8MM
 STEERER Ø: 28.6MM
 LENGTH: 70/80/90/100MM
 ANGLE: -17°
 WEIGHT: 158G (TBD)(80MM)



LYNX 0° DH STEM

ATB-959

LYNX 35 0° DH STEM

ATB-962

MATERIAL: AL6061
 HANDLEBAR Ø: 31.8/35MM
 STEERER Ø: 28.6MM
 LENGTH: 40/50MM
 ANGLE: +/-0°
 WEIGHT: 148G (TBD)(31.8, 40MM)
 140G (TBD)(35, 40MM)
 COLOR: LASER



LYNX 0° DH LIGHT STEM

ATB-961

LYNX 35 0° DH LIGHT STEM

ATB-963

MATERIAL: AL6061
 HANDLEBAR Ø: 31.8/35MM
 STEERER Ø: 28.6MM
 LENGTH: 40/50MM
 ANGLE: +/-0°
 WEIGHT: 132G (TBD)(31.8, 40MM)
 123G (TBD)(35, 40MM)
 COLOR: LASER



±40° DROP STEM

RAS-104

MATERIAL: AL6061
 HANDLEBAR Ø: 31.8MM
 STEERER Ø: 28.6MM
 ANGLE: ±40°
 LENGTH: 60/70/80/90/100/110/120/130MM
 WEIGHT: 168G (110MM)



FALCON CLIP-ON ADAPTOR KIT (STEM-MOUNTED)

TTH-1461S
MATERIAL: AL6061
WEIGHT: 74.5G / SET



ADAPTOR KIT FOR SQUARE STEM BODY

MATERIAL: AL6061
WEIGHT: 106.5G / SET
478G(WITH TTH-14)



ADAPTOR KIT FOR ROUND STEM BODY

MATERIAL: AL6061
WEIGHT: 91G / SET
464G(WITH TTH-14)



INTEGRATED SPLIT SPACER

HSS-11
MATERIAL: NYLON+GLASS FIBER
HEIGHT: 5/10MM
WEIGHT: 2.5G(5MM), 5G(10MM), 5G(TOP SPACER)
FOR RAS-88/RAS-101/ATB-960



INTEGRATED SPLIT SPACER

HSS-18
MATERIAL: NYLON+GLASS FIBER
HEIGHT: 5/10MM
WEIGHT: 2G(5MM), 4G(10MM), 2G(TOP SPACER)
FOR RAS-92



INTEGRATED SPLIT SPACER

HSS-19
MATERIAL: NYLON+GLASS FIBER
HEIGHT: 5/10MM
WEIGHT: 5.3G(5MM), 10.5G(10MM), 5.7G(TOP SPACER) (TBD)
FOR LYNX ATB-958



ATOM BAR TAPE

HT-14
MATERIAL: PU+SHOCKPROOF+SILICONE GEL
SIZE: 3CM X 210CM X 2.5MM
WEIGHT: 70G / PAIR (TBD)



ATOM DUO BAR TAPE

HT-13
MATERIAL: PU+SHOCKPROOF+SILICONE GEL
SIZE: 3CM X 210CM X 2.5MM
WEIGHT: 70G / PAIR (TBD)



VULCANO BAR TAPE

HT-15
MATERIAL: PU+SHOCKPROOF+SILICONE GEL
SIZE: 3CM X 210CM X 2.5MM
WEIGHT: 70G / PAIR (TBD)



ECCENTRIC RING

CR-48/SRAM
CR-49/SHIMANO
MATERIAL: AL7075
TYPE: 53/41, 51/36
BCD: 130(53/41)(SRAM), 110(53/41, 51/36)
WEIGHT: 187G (51/36, BCD 110)

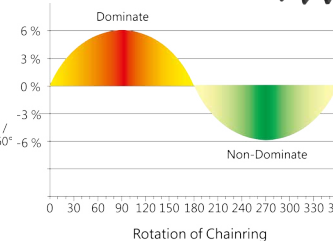
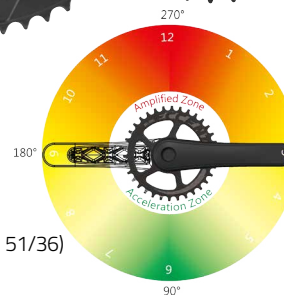

FTP up 6%
Lower input 6%

- 6% Power
- 6% Cadence
- Pedaling Naturally Round
- Easier Transition From Bike To Running

LYNX CARBON 29ER WIDE

RIM-85
MATERIAL: CARBON FIBER
FRONT HUB CNC AL6061: 110X15MM, 28 HOLES, 2 BEARINGS
REAR HUB CNC AL6061: 148X12MM, 28 HOLES, 4 BEARINGS
RIM DEPTH: 25MM
RIM WIDTH: 35MM
WEIGHT: 1500G / PAIR (TBD)
COLOR: RED/GRAY
TUBELESS READY RIME PROFILE
TOOLLESS CASSETTE BODY REMOVAL FOR EASY MAINTENANCE
COMPATIBLE WITH SHIMANO 11S/SRAM 10S & XD 11S

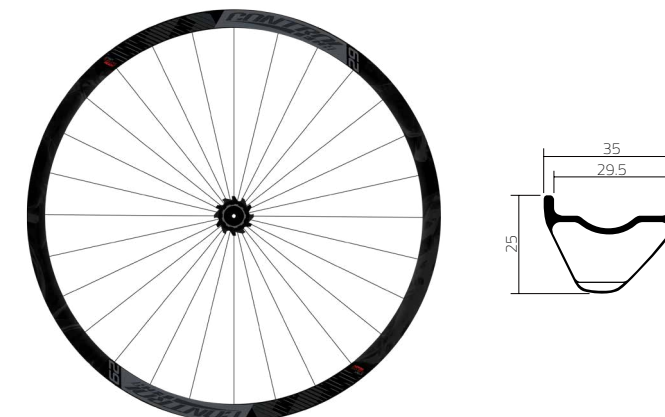

LYNX 29ER WIDE

RIM-86
MATERIAL: AL6061
FRONT HUB CNC AL6061: 110X15MM, 28 HOLES, 2 BEARINGS
REAR HUB CNC AL6061: 148X12MM, 28 HOLES, 4 BEARINGS
RIM DEPTH: 19MM
RIM WIDTH: 32MM
WEIGHT: 1600G / PAIR (TBD)
COLOR: RED/GRAY
TUBELESS READY RIME PROFILE
TOOLLESS CASSETTE BODY REMOVAL FOR EASY MAINTENANCE
COMPATIBLE WITH SHIMANO 11S/SRAM 10S & XD 11S

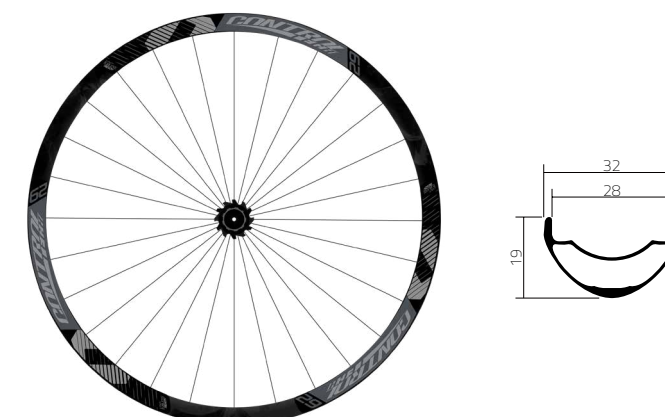

LYNX HUB

HUB-47
MATERIAL: AL6061
AXLE MATERIAL: STEEL
SPOKE HOLES: F/R 28
FRONT AXLE: 110 X 15MM (2 BEARINGS)
REAR AXLE: 148 X 12MM (4 BEARINGS)
WEIGHT: F 199G / R 236G (TBD)
DISC FITTING 6-BOLT
TOOLLESS CASSETTE BODY REMOVAL FOR EASY MAINTENANCE
COMPATIBLE WITH SHIMANO 11S/ SRAM 10S & XD 11S
CONICAL HUBSHELL IS LIGHT, STRONG AND ROBUST FOR OFFLOAD ABUSE

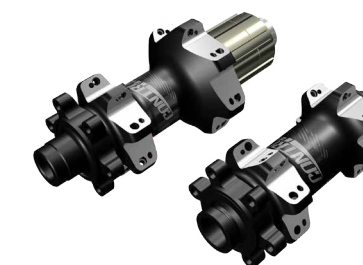

ROAD

OUR components are made with the best material and technology, for guarantee a perfect experience when you ride.

COUGAR

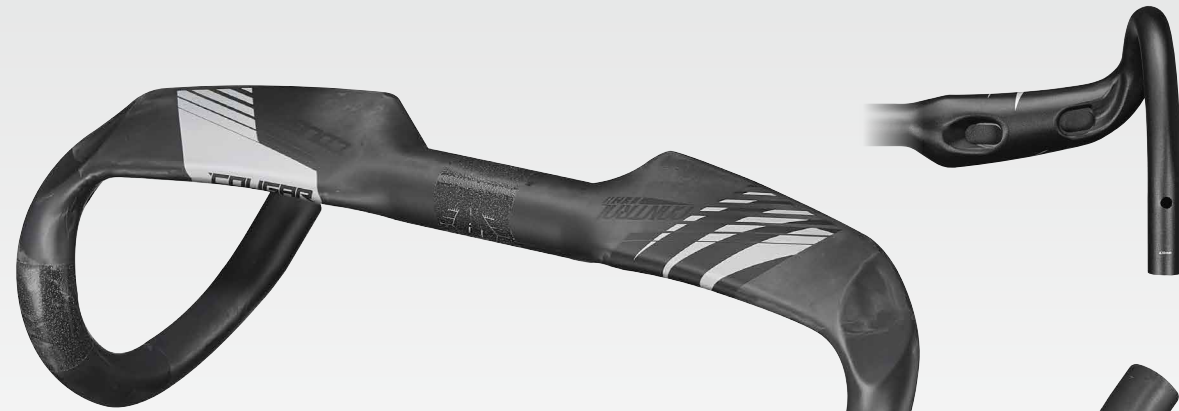

COUGAR FL4 CARBON HANDLEBAR

RA-522
 MATERIAL: UD CARBON
 BARBORE Ø: 31.8MM
 WIDTH: 380/400/420/440MM
 REACH: 78MM/70(W380)
 DROP: 125MM
 FLARE: 4°
 WEIGHT: 216G(420MM)
 COMPATIBLE WITH EW-RS910

W1	
380	400
400	420
420	440
440	460

W2	
380	400
400	420
420	440
440	460



COUGAR FL4 ALLOY ERGO HANDLEBAR

RA-531
 MATERIAL: AL6061
 BARBORE Ø: 31.8MM
 WIDTH: 400/420/440MM
 REACH: 78MM
 DROP: 125MM
 FLARE: 4°
 WEIGHT: 350G (420MM)
 COMPATIBLE WITH EW-RS910

W1	
400	420
420	440
440	460

W2	
400	420
420	440
440	460



COUGAR FL4 ALLOY HANDLEBAR

RA-527
 MATERIAL: AL6061
 BARBORE Ø: 31.8MM
 WIDTH: 380/400/420/440MM
 REACH: 75MM/70MM(W380)
 DROP: 125MM
 FLARE: 4°
 WEIGHT: 370G (420MM)
 COMPATIBLE WITH EW-RS910

W1	
380	400
400	420
420	440
440	460

W2	
380	400
400	420
420	440
440	460



COUGAR FL4 ALLOY HANDLEBAR

RA-535
 MATERIAL: AL6061
 BARBORE Ø: 31.8MM
 WIDTH: 380/400/420/440MM
 REACH: 78MM
 DROP: 125MM
 FLARE: 4°
 WEIGHT: 350G (420MM)
 COMPATIBLE WITH EW-RS910
 PASSED ZEDLER ADVANCED TEST

W1	
380	400
400	420
420	440
440	460

W2	
380	400
400	420
420	440
440	460





COUGAR HEADSET

HS-957
MATERIAL: AL6061
SIZE: UPPER 1-1/8" BOTTOM 1-1/2"
DIAMETER Ø: 48MM
WEIGHT: 108G



COUGAR -5° STEM

RAS-92
MATERIAL: AL6061
HANDLEBAR Ø: 31.8MM
STEERER Ø: 28.6MM
LENGTH: 90/100/110/120MM
ANGLE: -5°
WEIGHT: 182G (110MM)



COUGAR -6° AERO ALLOY STEM

RAS-94
MATERIAL: AL6061
HANDLEBAR Ø: 31.8MM
STEERER Ø: 28.6MM
LENGTH: 80/90/100/110MM
ANGLE: -6°
WEIGHT: 240G (110MM)
INTEGRATED STEM CAP, HIDDEN FACEPLATE BOLTS

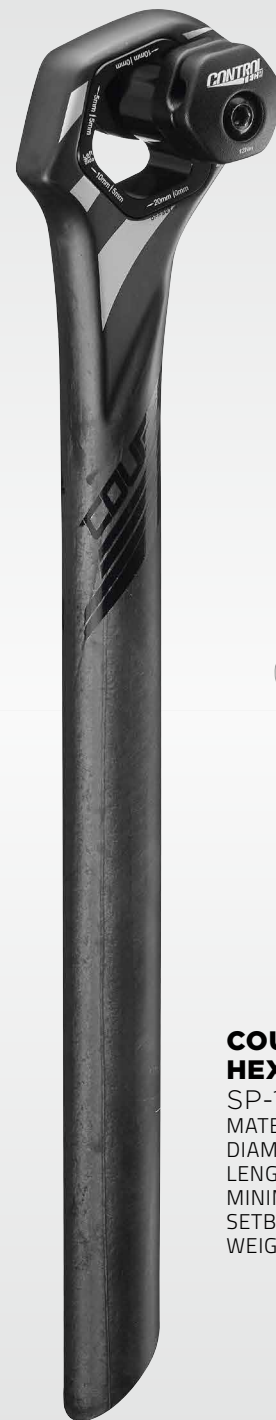

COUGAR CARBON HEX SEATPOST

SP-1570
MATERIAL: CARBON FIBER
DIAMETER Ø: 27.2/31.6MM
LENGTH: 350MM
MINIMUM INSERT: 90MM
SETBACK: 20/10/-5/-10MM
WEIGHT: 245G (27.2MM)



PCS Thru Axle

QR-41
MATERIAL: AL6061
FRONT: M12 x 100MM
REAR: M12 x 142MM
WEIGHT: F 63G / R 75G
For Pure Cockpit System only



F-176I

COUGAR FORK

F-175I (INTERNAL)
F-176I (EXTERNAL)
MATERIAL: CARBON FIBER
STEERER: UP 1-1/8"
DOWN: 1-1/2"
CROWN: 57MM
CROWN RACE: 39.8MM
SETBACK: 43MM
WEIGHT: 475MM
FLAT MOUNT
COUGAR HANDLEBAR COMPATIBLE
WITH TA-12 THRU-AXLE

F-175I

TIMANIA



TIMANIA FLO ROAD HANDLEBAR

RA509-8
 MATERIAL: TI + UD CARBON
 BARBORE Ø: 31.8MM
 WIDTH: 400/420/440MM
 REACH: 75MM
 DROP: 130MM
 WEIGHT: 235G (W420MM)



MONOCOQUE FORMING PROCESS
 INSIDE TITANIUM TUBE



TIMANIA ±5° STEM

ATB-937
 MATERIAL: 6AL-4V TITANIUM
 HANDLEBAR Ø: 31.8MM
 STEERER Ø: 28.6MM
 LENGTH: 70/90/100/110/120MM
 ANGLE: +/-5°
 WEIGHT: 129G (110MM)



TIMANIA BOTTLE CAGE

BC-30
 MATERIAL: 3AL-2.5V TITANIUM
 WEIGHT: 48G



TIMANIA SB12 SEATPOST

SP-1330
 MATERIAL: 3AL-2.5V TITANIUM
 DIAMETER Ø: 27.2/31.6MM
 LENGTH: 350MM
 MINIMUM INSERT: 90MM
 SETBACK: 12MM
 WEIGHT: 203G (27.2MM)



TIMANIA STEM CAP

CAP-44
 MATERIAL: TITANIUM
 STEERER Ø: 23.3-25.4
 BOLT: ALUMINUM
 WEIGHT: 34G



TIMANIA SEAT CLAMP

SC-102
 MATERIAL: 6AL-4V TITANIUM
 ID Ø: 31.8MM/34.9MM
 WEIGHT: 20G (34.9MM)



TIMANIA SPACERS

HSS-12
 MATERIAL: TITANIUM
 HEIGHT: 5/10/15MM
 WEIGHT: 2/4/7G

TUX



TUX FL4 COMPACT HANDLEBAR

RA-523
 MATERIAL: UD CARBON
 BARBORE Ø: 31.8MM
 WIDTH: 380/400/420/440MM
 REACH: 70(380)/75MM
 DROP: 125MM
 FLARE: 4°
 WEIGHT: 177G (420MM)
 COLOR: RED/GRAY
 COMPATIBLE WITH EW-RS910
 PASSED ZEDLER ADVANCED TEST

W1	
380	400
400	420
420	440
440	460

W2	
380	400
400	420
420	440
440	460



TUX ±5° STEM

RAS-79-FUD
 MATERIAL: CARBON FIBER+AL7075
 HANDLEBAR Ø: 31.8MM
 STEERER Ø: 28.6MM
 LENGTH: 70/80/90/100/110/120/130MM
 ANGLE: +/- 5°
 WEIGHT: 125G (110MM)
 COLOR: RED/GRAY



TUX ROAD FORK

F-149I
 MATERIAL: CARBON FIBER
 STEERER: UP 1-1/8"
 DOWN: 1-1/2"
 CROWN: 56MM
 CROWN RACE: 39.8MM
 SETBACK: 45MM
 WEIGHT: 400G
 COLOR: RED/GRAY



TUX LIGHT SB0 SEATPOST

SP-1600
 MATERIAL: CARBON FIBER
 DIAMETER Ø: 31.6MM
 LENGTH: 400MM
 MINIMUM INSERT: 100MM
 SETBACK: 0MM
 WEIGHT: 245G (31.6MM)
 COLOR: RED/GRAY



TUX LIGHT SB20 SEATPOST

SP-1610
 MATERIAL: CARBON FIBER
 DIAMETER Ø: 27.2MM
 LENGTH: 350MM
 MINIMUM INSERT: 90MM
 SETBACK: 20MM
 WEIGHT: 212G (27.2MM)
 COLOR: RED/GRAY



TUX SB0 SEATPOST

SP-1620
 MATERIAL: CARBON FIBER
 DIAMETER Ø: 27.2/31.6MM
 LENGTH: 400MM
 MINIMUM INSERT: 100MM
 SETBACK: 0MM
 WEIGHT: 190G (31.6MM)
 COLOR: RED/GRAY



TUX SB10 SEATPOST

SP-1630
 MATERIAL: CARBON FIBER
 DIAMETER Ø: 27.2/31.6MM
 LENGTH: 350MM
 MINIMUM INSERT: 90MM
 SETBACK: 10MM
 WEIGHT: 185G (27.2MM)
 COLOR: RED/GRAY

EXL

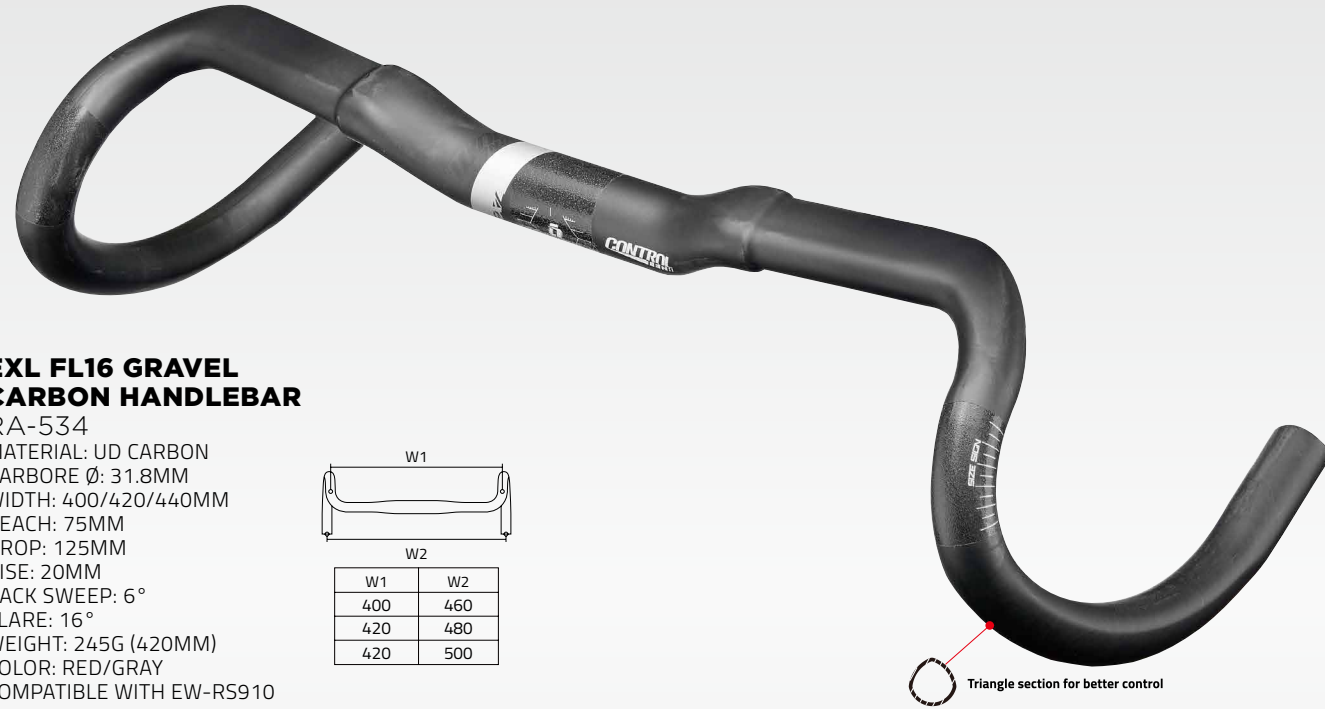

EXL FL16 GRAVEL CARBON HANDLEBAR

RA-534
 MATERIAL: UD CARBON
 BARBORE Ø: 31.8MM
 WIDTH: 400/420/440MM
 REACH: 75MM
 DROP: 125MM
 RISE: 20MM
 BACK SWEEP: 6°
 FLARE: 16°
 WEIGHT: 245G (420MM)
 COLOR: RED/GRAY
 COMPATIBLE WITH EW-RS910

W1	
W2	
W1	W2
400	460
420	480
420	500

Triangle section for better control



EXL FL4 COMPACT HANDLEBAR

RA-526
 MATERIAL: UD CARBON
 BARBORE Ø: 31.8MM
 WIDTH: 400/420/440MM
 REACH: 75MM
 DROP: 125MM
 FLARE: 4°
 WEIGHT: 195G (420MM)
 COLOR: RED/GRAY
 COMPATIBLE WITH EW-RS910

W1	
W2	
W1	W2
400	420
420	440
440	460

Triangle section for better control

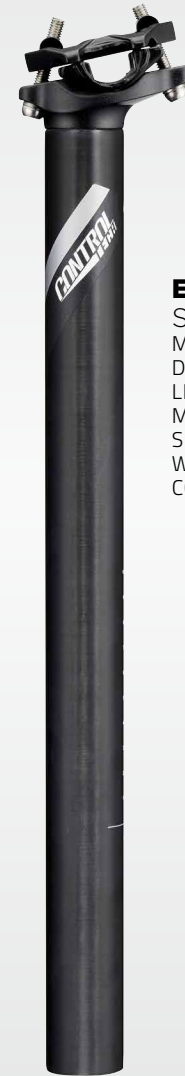

EXL SB10 SEATPOST

SP-1280UD
 MATERIAL: CARBON FIBER
 DIAMETER Ø: 27.2/30.9/31.6MM
 LENGTH: 350/400MM
 MINIMUM INSERT: 90MM(350L), 100MM(400L)
 SETBACK: 10MM
 WEIGHT: 227G (27.2MM, 350L)
 COLOR: RED/GRAY

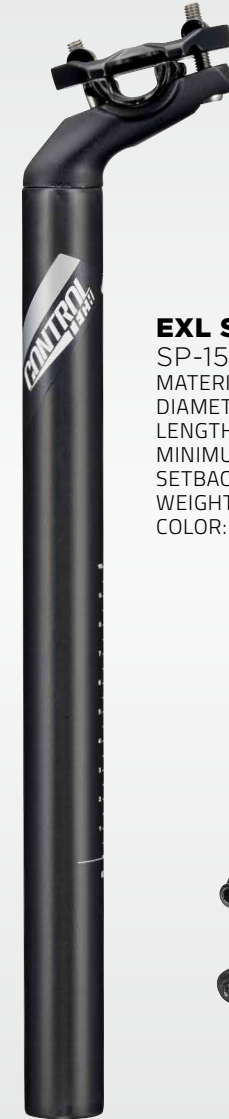

EXL SB23 SEATPOST

SP-1500UD
 MATERIAL: CARBON FIBER
 DIAMETER Ø: 27.2/31.6MM
 LENGTH: 350MM
 MINIMUM INSERT: 90MM
 SETBACK: 23MM
 WEIGHT: 244G (27.2MM)
 COLOR: RED/GRAY



EXL ±5° STEM

RAS-82-FUD
 MATERIAL: CARBON FIBER+AL6061
 HANDLEBAR Ø: 31.8MM
 STEERER Ø: 28.6MM
 LENGTH: 60/70/80/90/100/110/120/130MM
 ANGLE: +/- 5°
 WEIGHT: 145G (110MM)
 COLOR: RED/GRAY

SLA



SLA FL4 COMPACT HANDLEBAR

RA-513
 MATERIAL: AL7050
 BARBORE Ø: 31.8MM
 WIDTH: 400/420/440MM
 REACH: 75MM
 DROP: 125MM
 FLARE: 4°
 WEIGHT: 250G (420MM)
 COLOR: RED/GRAY
 COMPATIBLE WITH EW-RS910

W1	
400	420
420	440
W2	
440	460

Triangle section for better control



SLA FLO ERGO HANDLEBAR

RA-519DB7-8
 MATERIAL: AL7050
 BARBORE Ø: 31.8MM
 WIDTH: 380/400/420/440MM
 REACH: 70MM
 DROP: 125MM
 WEIGHT: 286G (420MM)
 COLOR: RED/GRAY



SLA LIGHT SB12 SEATPOST

SP-1560
 MATERIAL: AL7050
 DIAMETER Ø: 27.2MM
 LENGTH: 350MM
 MINIMUM INSERT: 90MM
 SETBACK: 12MM
 WEIGHT: 243G
 COLOR: RED/GRAY



SLA SB10 SEATPOST

SP-988
 MATERIAL: AL7075
 DIAMETER Ø: 27.2/30.9/31.6MM
 LENGTH: 350/400MM
 MINIMUM INSERT: 90MM(350L), 100MM(400L)
 SETBACK: 10MM
 WEIGHT: 242G (27.2MM, 350L)
 COLOR: RED/GRAY



SLA SB23 SEATPOST

SP-1480
 MATERIAL: AL2014
 DIAMETER Ø: 27.2/31.6MM
 LENGTH: 350MM
 MINIMUM INSERT: 90MM
 SETBACK: 23MM
 WEIGHT: 242G (27.2MM)
 COLOR: RED/GRAY



SLA ±5° STEM

RAS-85
 MATERIAL: AL7075
 HANDLEBAR Ø: 31.8MM
 STEERER Ø: 28.6MM
 LENGTH: 70/80/90/100/110/120/130MM
 ANGLE: +/- 5°
 WEIGHT: 110G (110MM)
 COLOR: RED/GRAY

CLS



CLS FLO ROAD HANDLEBAR

RA-510DB6-8
 MATERIAL: AL6061
 BARBORE Ø: 31.8MM
 WIDTH: 380/400/420/440MM
 REACH: 70MM
 BACK SWEEP: 6°
 DROP: 124MM (W380/400MM)
 126MM (W420/440MM)
 WEIGHT: 290G (420MM)
 COLOR: RED/GRAY



CLS FL4 COMPACT HANDLEBAR

RA-533
 MATERIAL: AL6061
 BARBORE Ø: 31.8MM
 WIDTH: 400/420/440MM
 REACH: 75MM
 DROP: 125MM
 FLARE: 4°
 WEIGHT: 293G (420MM)
 COLOR: RED/GRAY

W1	
[Diagram showing W1 width]	
W2	
W1	W2
400	420
420	440
440	460



CLS FL16 GRAVEL RISER

RA-530
 MATERIAL: AL6061
 BARBORE Ø: 31.8MM
 WIDTH: 380/400/420/440MM
 REACH: 75MM
 DROP: 125MM
 RISE: 20MM
 FLARE: 16°
 WEIGHT: 330G (420MM)
 COLOR: RED/GRAY

W1	
[Diagram showing W1 width]	
W2	
W1	W2
380	475
400	495
420	515
440	535



CLS FL4 ROAD RISER

RA-532
 MATERIAL: AL6061
 BARBORE Ø: 31.8MM
 WIDTH: 380/400/420/440MM
 REACH: 75MM
 DROP: 125MM
 RISE: 20MM
 FLARE: 4°
 WEIGHT: 330G (420MM)
 COLOR: RED/GRAY

W1	
[Diagram showing W1 width]	
W2	
W1	W2
380	405
400	425
420	445
440	465

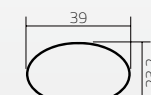
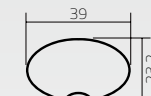

Triangle section for better control

Triangle section for better control



CL5 FL12 GRAVEL HANDLEBAR

RA-518DB6-8
 MATERIAL: AL6061
 BARBORE Ø: 31.8MM
 WIDTH: 400/420/440/460MM
 REACH: 75MM
 DROP: 130MM
 FLARE: 12°
 WEIGHT: 300G (420MM)
 COLOR: RED/GRAY

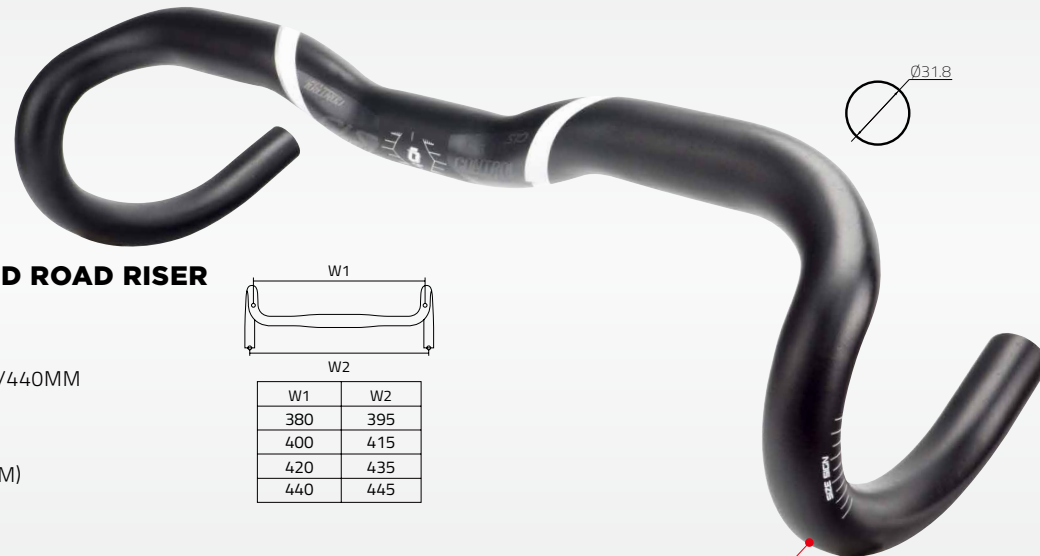
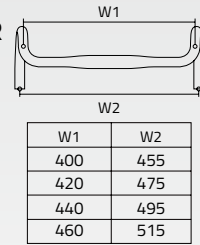

CL5 FL4 ROUND ROAD RISER

RA-537
 MATERIAL: AL6061
 BARBORE Ø: 31.8MM
 WIDTH: 380/400/420/440MM
 REACH: 75MM
 DROP: 125MM
 RISE: 20MM
 WEIGHT: 330G (420MM)
 COLOR: RED/GRAY

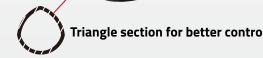
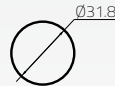
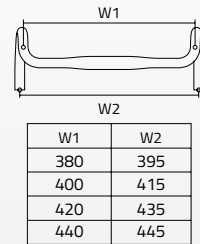

CL5 FLO ROAD RISER

RA-538
 MATERIAL: AL6061
 BARBORE Ø: 31.8MM
 WIDTH: 380/400/420/440MM
 REACH: 70MM
 DROP: 125MM
 RISE: 20MM
 WEIGHT: 330G (420MM)
 COLOR: RED/GRAY

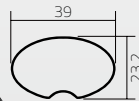

CL5 ±17° DROP STEM

RAS-117
 MATERIAL: AL6061
 HANDLEBAR Ø: 31.8MM
 STEERER Ø: 28.6MM
 LENGTH: 70/80/90/100/110/120MM
 ANGLE: +/- 17°
 WEIGHT: 145G(110MM)
 COLOR: RED/GRAY



CL5 ±5° STEM

RAS-110
 MATERIAL: AL6061
 HANDLEBAR Ø: 31.8MM
 STEERER Ø: 28.6MM
 LENGTH: 60/70/80/90/100/110/120MM
 ANGLE: +/- 5°
 WEIGHT: 118G (110MM)
 COLOR: RED/GRAY



CL5 SB10 SEATPOST

SP-1180
 MATERIAL: AL6061
 DIAMETER Ø: 27.2/31.6MM
 LENGTH: 350MM
 MINIMUM INSERT: 90MM
 SETBACK: 10MM
 WEIGHT: 285G (27.2MM, 350L)
 COLOR: RED/GRAY



CL5 SB23 SEATPOST

SP-1480
 MATERIAL: AL6061
 DIAMETER Ø: 27.2/31.6MM
 LENGTH: 350MM
 MINIMUM INSERT: 90MM
 SETBACK: 23MM
 WEIGHT: 287G (27.2MM)
 COLOR: RED/GRAY

FALCON



FALCON FLO ERGO HANDLEBAR

RA-519DB6-8
 MATERIAL: AL6061
 BARBORE Ø: 31.8MM
 WIDTH: 400/420/440MM
 REACH: 70MM
 DROP: 125MM
 WEIGHT: 315G (420MM)
 COLOR: RED/GRAY



FALCON ±5° STEM

RAS-88
 MATERIAL: AL6061
 HANDLEBAR Ø: 31.8MM
 STEERER Ø: 28.6MM
 LENGTH: 80/90/100/110/120/130/140MM
 ANGLE: +/-5°
 WEIGHT: 195G(110MM)
 COLOR: RED/GRAY
 TOP CAP INCLUDED AND INTEGRATED ALLOY
 SPACER INCLUDED



FALCON -8° AERO STEM

RAS-101
 MATERIAL: AL6061
 HANDLEBAR Ø: 31.8MM
 STEERER Ø: 28.6MM
 LENGTH: 80/90/100/110/120MM
 ANGLE: -8°
 WEIGHT: 170G (110MM)
 COLOR: RED/GRAY



FALCON STEM INTEGRATED SPACER

HSS-14
 MATERIAL: AL6061
 HEIGHT: 10MM
 WEIGHT: 10G



FALCON ALLOY HEX SEATPOST

SP-1540
 MATERIAL: AL60661
 DIAMETER Ø: 27.2/31.6MM
 LENGTH: 350MM
 MINIMUM INSERT: 90MM
 SETBACK: 20/10/-5/-10MM
 WEIGHT: 355G (27.2MM)
 COLOR: RED/GRAY



FALCON SB20 SEATPOST

SP-1020
 MATERIAL: AL6061
 DIAMETER Ø: 27.2/31.6MM
 LENGTH: 300/350/400MM
 MINIMUM INSERT: 90MM(300/350L), 100MM(400L)
 SETBACK: 20MM
 WEIGHT: 270G (27.2MM, 300L)
 COLOR: RED/GRAY



FALCON WATER BOTTLE

WBT-05
 MATERIAL: PLASTIC
 VOLUME: 600ML
 WEIGHT: 70G
 COLOR: RED/GRAY



FALCON SPEED SADDLE

SD-20
 SHELL: POLYCARBONATE
 RAILS: HOLLOW CHROMOLY
 LENGTH: 285MM
 WIDTH: 132MM
 WEIGHT: 237G



**FALCON MINI CLIP-ON
(HANDLEBAR MOUNTED)**

TTH-14
 MATERIAL: AL6061
 CLAMP Ø: 31.8MM
 LENGTH: MAX 183MM(C TO TOP), MIN 143MM
 EXTENSION: U BAR, UP 29MM(C TO C)
 ARMREST'S R/L ADJUSTABLE: R/30MM, L/30MM
 ARMREST'S +/- ADJUSTABLE ANGLE: 15°(+/-7.5°)
 OPTION SPACERS: 20/40/60MM
 WEIGHT: 407G (WITH PAD)
 COLOR: RED/GRAY



FALCON TT BAR PAD

TTH-15P
 MATERIAL: EVA
 WEIGHT: 13G / PAIR



FALCON TT ALLOY EXTENSION S BEND

TTH-15
 MATERIAL: AL6061
 CLAMP Ø: 31.8MM
 EXTENSION BAR RISE: 29MM
 LENGTH: MAX 303MM(C TO TOP), MIN 253MM
 ARMRESTS R / L ADJUSTABLE : R/30MM, L/30MM
 ARMRESTS F / B ADJUSTABLE : F/50MM, B/50MM
 ARMREST'S +/- ADJUSTABLE ANGLE: 10°(+/-5°)
 OPTION SPACERS: 20/40/60MM
 WEIGHT: 450G (WITH PADS)
 COLOR: RED/GRAY



FALCON TRI ALLOY EXTENSION J BEND

TTH-16
 MATERIAL: AL6061
 CLAMP Ø: 31.8MM
 EXTENSION BAR ANGLE: 40°
 LENGTH: MAX 303MM(C TO TOP), MIN 253MM
 ARMRESTS R / L ADJUSTABLE : R/30MM, L/30MM
 ARMRESTS F / B ADJUSTABLE : F/50MM, B/50MM
 ARMREST'S +/- ADJUSTABLE ANGLE: 10°(+/-5°)
 OPTION SPACERS: 20/40/60MM
 WEIGHT: 462G (WITH PADS)
 COLOR: RED/GRAY



UP GRADE
**FALCON CLIP-ON ADAPTOR KIT
(STEM-MOUNTED)**

TTH-1461S
 MATERIAL: AL6061
 WEIGHT: 74.5G / SET



**ADAPTOR KIT FOR
SQUARE STEM BODY**

MATERIAL: AL6061
 WEIGHT: 106.5G / SET
 478G(WITH TTH-14)



**ARMREST STACK SPACER KIT
20MM**

TTH-15M
 MATERIAL: AL6061
 HEIGHT: 20MM
 WEIGHT: 90G / SET



**ARMREST STACK SPACER KIT
40MM**

TTH-15M
 MATERIAL: AL6061
 HEIGHT: 40MM
 WEIGHT: 158G / SET



**ARMREST STACK SPACER KIT
60MM**

TTH-15M
 MATERIAL: AL6061
 HEIGHT: 60MM
 WEIGHT: 226G / SET



**ADAPTOR KIT FOR
ROUND STEM BODY**

MATERIAL: AL6061
 WEIGHT: 91G / SET
 464G(WITH TTH-14)



TIME ZONE AEROBAR PAD

TTH-17P
 MATERIAL: LYCRA+EVA
 WEIGHT: 12G / PAIR
 ELBOW PAD OF TIME ZONE AEROBAR



FALCON BOTTLE CAGE

BC-33
 MATERIAL: PLASTIC
 WEIGHT: 30G
 COLOR: RED/GRAY



**FALCON REAR
HYDRATION SYSTEMS**

BC-31
 MATERIAL: AL6061+PLASTIC
 CAPACITY: 2 OR 1 BOTTLES / 1 CO2 CANISTER
 ADJUSTMENT: ANGLE UP TO 45°, UP TO 30MM
 WEIGHT: 202G
 COLOR: RED/GRAY

ONE



ONE FLO GRAVEL 500

RA-536
MATERIAL: AL6061
BARBORE Ø: 31.8MM
WIDTH: 500MM
REACH: 78MM
DROP: 125MM
RISE: 20MM
WEIGHT: 350G



ONE FLO ROAD HANDLEBAR

RA-473DB6-8
MATERIAL: AL6061
BARBORE Ø: 31.8MM
WIDTH: 380/400/420/440MM
REACH: 78MM
DROP: 140MM
WEIGHT: 314G (420MM)
COLOR: DECAL/LASER



ONE FLO ROUND HANDLEBAR

RA-492DB68
MATERIAL: AL6061
BARBORE Ø: 31.8MM
WIDTH: 360/380/400/420/440MM
REACH: 70MM (360/380MM), 75MM (400/420/440MM)
DROP: 125MM (360/380MM), 128MM (400/420/440MM)
WEIGHT: 305G (420MM)
COLOR: DECAL/LASER



ONE ±5° STEM

RAS-80
MATERIAL: AL6061
HANDLEBAR Ø: 31.8MM
STEERER Ø: 28.6MM
LENGTH: 60/70/80/90/100/110/120/130MM
ANGLE: +/-5°
WEIGHT: 137G (110MM)
COLOR: DECAL/LASER



ONE ±17° DROP STEM

RAS-217
MATERIAL: AL6061
HANDLEBAR Ø: 31.8MM
STEERER Ø: 28.6MM
LENGTH: 70/80/90/100/110/120MM
ANGLE: +/-17°
WEIGHT: 145G (110MM)
COLOR: DECAL/LASER



ONE SB10 SEATPOST

SP-1080
MATERIAL: AL6061
DIAMETER Ø: 27.2/30.9/31.6MM
LENGTH: 350/400MM
MINIMUM INSERT: 90MM(350L), 100MM(400L)
SETBACK: 10MM
WEIGHT: 285G (27.2MM, 350L)
COLOR: DECAL/LASER

OE



OE FLO ROAD HANDLEBAR

RA-540
MATERIAL: AL6061
BARBORE Ø: 31.8MM
WIDTH: 360/380/400/420/440MM
REACH: 70MM
DROP: 125MM
WEIGHT: 300G (420MM)



OE ±5° STEM

RAS-99
MATERIAL: AL6061
HANDLEBAR Ø: 31.8MM
STEERER Ø: 28.6MM
LENGTH: 60/70/80/90/100/110/120MM
ANGLE: +/-5°
WEIGHT: 137G(110MM)



OE SB10 SEATPOST

SP-1640
MATERIAL: AL6061
DIAMETER Ø: 27.2/30.9/31.6MM
LENGTH: 350/400MM
MINIMUM INSERT: 90MM(350L), 100MM(400L)
SETBACK: 10MM
WEIGHT: 305G (27.2MM, 350L)



ROAD COLLECTION SPEC

STEM	COUGAR AERO	COUGAR	TIMANIA	TUX	EXL	SLA	CLS	CLS DROP	FALCON	FALCON AERO	ONE	ONE DROP	OE
ANGLE	-6°	-5°	±5°	±5°	±5°	±5°	±5°	±17°	±5°	-8°	±5°	±17°	±5°
40													
45													
50													
60					V		V				V		V
70			V	V	V	V	V	V			V	V	V
80	V			V	V	V	V	V	V	V	V	V	V
90	V	V	V	V	V	V	V	V	V	V	V	V	V
100	V	V	V	V	V	V	V	V	V	V	V	V	V
110	V	V	V	V	V	V	V	V	V	V	V	V	V
120		V	V	V	V	V	V	V	V	V	V	V	V
130				V	V	V			V		V		
140								V					
STACK HEIGHT(MM)	36	35	40	40	40	40	40	40	30.5	36	40	40	40
STEERER Ø(MM)	28.6	28.6	28.6	28.6	28.6	28.6	28.6	28.6	28.6	28.6	28.6	28.6	28.6
BARBORE Ø(MM)	31.8	31.8	31.8	31.8	31.8	31.8	31.8	31.8	31.8	31.8	31.8	31.8	31.8
BODY	AL6061	AL6061	MONOCOQUE TITANIUM	AL7075+ CARBON	AL6061+ CARBON	AL7075	AL6061	AL6061	AL6061	AL6061	AL6061	AL6061	AL6061
FACEPLATE	AL6061	AL6061	6AL-4V TITANIUM	AL7075+ CARBON	AL6061	AL7075	AL6061	AL6061	AL6061	AL6061	AL6061	AL6061	AL6061
BOLT	SCM-435	SCM-435	6AL-4V TITANIUM	STAINLESS STEEL	SCM-435	STAINLESS STEEL	SCM-435	SCM-435	SCM-435	SCM-435	SCM-435	SCM-435	SCM-435
LOGO APPLICATION	COLOR DECAL	COLOR DECAL	LASER	COLOR DECAL	COLOR DECAL	COLOR DECAL	COLOR DECAL	COLOR DECAL	COLOR DECAL	COLOR DECAL	DECAL/LASER	DECAL/LASER	LASER
FINISH	SB BLACK	SB BLACK	TITANIUM	CARBON	CARBON	SB BLACK	SB BLACK	SB BLACK	SB BLACK	SB BLACK	SB BLACK	SB BLACK	SB BLACK
WEIGHT	240G (110MM)	182G (110MM)	129G (110MM)	125G (110MM)	145G (110MM)	110G (110MM)	118G (110MM)	145G (110MM)	195G (110MM)	170G (110MM)	137G (110MM)	145G (110MM)	137G (110MM)

ROAD BARS

	COUGAR FL4 CARBON	COUGAR FL4 AERO	COUGAR FL4 ALLOY ERGO	COUGAR FL4 ALLOY	TIMANIA FLO ROAD	TUX FL4 COMPACT	EXL FL16 GRAVEL	EXL FL4 COMPACT	SLA FL4 COMPACT	SLA FLO ERGO	CLS FLO ROAD
BARBORE	31.8	31.8	31.8	31.8	31.8	31.8	31.8	31.8	31.8	31.8	31.8
360											
380	V	V		V		V				V	V
400	V	V	V	V	V	V	V	V	V	V	V
420	V	V	V	V	V	V	V	V	V	V	V
440	V	V	V	V	V	V	V	V	V	V	V
460											
DROP(MM)	125	125	125	125	130	125	125	125	125	125	124(W380-400) 126(W420-440)
REACH	70(W380) 78	70(W380) 75	78	78	75	70(W380) 75	75	75	75	75	70
FLARE	4°	4°	4°	4°		4°	16°	4°	4°		
BACK SWEEP							6°				6°
RISE							20				
CABLE ROUTING	GROOVE	GROOVE	GROOVE	GROOVE	GROOVE	GROOVE	GROOVE	GROOVE	GROOVE	GROOVE	GROOVE
MATERIAL	CARBON	AL6061	AL6061	AL6061	TI+CARBON	CARBON	CARBON	CARBON	AL7050	AL7050	AL6061
LOGO APPLICATION	COLOR DECAL	COLOR DECAL	COLOR DECAL	COLOR DECAL	DECAL+LASER	COLOR DECAL	COLOR DECAL	COLOR DECAL	COLOR DECAL	COLOR DECAL	COLOR DECAL
FINISH	CARBON	SB BLACK	SB BLACK	SB BLACK	TITANIUM	CARBON	CARBON	CARBON	SB BLACK	SB BLACK	SB BLACK
WEIGHT	216G (420MM)	370G (420MM)	350G (420MM)	350G (420MM)	235G (420MM)	177G (420MM)	245G (420MM)	195G (420MM)	250G (420MM)	286G (420MM)	290G (420MM)

ROAD BARS

	CLS FL4 COMPACT	CLS FL16 GRAVEL	CLS FL4 ROAD	CLS FL12 GRAVEL	CLS FL4 ROUND	CLS FLO ROAD	FALCON FLO ERGO	ONE FLO GRAVEL	ONE FLO ROAD	ONE FLO ROUND	OE ROAD
BARBORE	31.8	31.8	31.8	31.8	31.8	31.8	31.8	31.8	31.8	31.8	31.8
360										V	V
380		V	V		V	V		V	V	V	V
400	V	V	V	V	V	V	V	V	V	V	V
420	V	V	V	V	V	V	V	V	V	V	V
440	V	V	V	V	V	V	V	V	V	V	V
460				V							
500								V			
DROP(MM)	125	125	125	130	125	125	125	125	140	125(W360-380) 128(W400-440)	125
REACH	75	75	75	75	75	70	70	78	78	70(W360-380) 75(W400-440)	70
FLARE	4°	16°	4°	12°	4°						
BACK SWEEP											
RISE		20	20		20	20		20			
CABLE ROUTING	GROOVE	GROOVE	GROOVE	GROOVE	GROOVE	GROOVE	GROOVE	GROOVE	GROOVE	GROOVE	GROOVE
MATERIAL	AL6061	AL6061	AL6061	AL6061	AL6061	AL6061	AL6061	AL6061	AL6061	AL6061	AL6061
LOGO APPLICATION	COLOR DECAL	COLOR DECAL	COLOR DECAL	COLOR DECAL	COLOR DECAL	COLOR DECAL	COLOR DECAL	COLOR DECAL	DECAL/LASER	DECAL/LASER	DECAL/LASER
FINISH	SB BLACK	SB BLACK	SB BLACK	SB BLACK	SB BLACK	SB BLACK	SB BLACK	SB BLACK	SB BLACK	SB BLACK	SB BLACK
WEIGHT	293G (420MM)	330G (420MM)	330G (420MM)	300G (420MM)	330G (420MM)	330G (420MM)	315G (420MM)	350G	314G (420MM)	305G (420MM)	300G (420MM)

SEATPOST		COUGAR HEX CARBON	TIMANIA SB12 SETBACK	TUX LIGHT SBO	TUX LIGHT SB10	TUX SBO	TUX SB10	EXL SB10	EXL SB23	SLA LIGHT SB12	SLA SB10
LENGTH (MM)	250										
	300										
	350	V	V		V		V	V	V	V	V
	400			V		V		V			V
	410										
DIAMETER (MM)	27.2	V	V		V	V	V	V	V	V	V
	30.9							V			V
	31.6	V	V	V		V	V	V	V		V
SETBACK(MM)		20/10/-5/-10	12	0	20	0	10	10	23	12	10
MATERIAL	TUBE	CARBON	3AL-2.5V TITANIUM	CARBON	CARBON	CARBON	CARBON	CARBON	CARBON	AL7050	AL7075
	CLAMP	AL6061	CARBON	AL6066	AL6066	AL2014	AL2014	AL2014	AL2014	AL6061	AL2014
	BOLT	SCM-435	6AL-4V TITANIUM	STAINLESS STEEL	STAINLESS STEEL	STAINLESS STEEL	STAINLESS STEEL	STAINLESS STEEL	STAINLESS STEEL	SCM-435	STAINLESS STEEL
LOGO APPLICATION		COLOR DECAL	LASER	COLOR DECAL	COLOR DECAL	COLOR DECAL	COLOR DECAL	COLOR DECAL	COLOR DECAL	COLOR DECAL	COLOR DECAL
FINISH		CARBON	TITANIUM	CARBON	CARBON	CARBON	CARBON	CARBON	CARBON	SB BLACK	SB BLACK
WEIGHT		245G (L350/Ø27.2)	203G (L350/Ø27.2)	245G (L400/Ø31.6)	212G (L350/Ø27.2)	190G (L400/Ø31.6)	185G (L350/Ø27.2)	227G (L350/Ø27.2)	244G (L350/Ø27.2)	243G (L350/Ø27.2)	242G (L350/Ø27.2)

SEATPOST		SLA SB23	CLS SB10	CLS SB23	FALCON HEX ALLOY	FALCON SB20	ONE SB10	OE SB10
LENGTH (MM)	250							
	300					V		
	350	V	V	V	V	V	V	V
	400					V	V	V
	410							
DIAMETER (MM)	27.2	V	V	V	V	V	V	V
	30.9						V	V
	31.6	V	V	V	V	V	V	V
SETBACK(MM)		23	10	23	20/10/-5/-10	20	10	10
MATERIAL	TUBE	AL2014	AL6061	AL6061	AL6061	AL6061	AL6061	AL6061
	CLAMP	AL2014	AL2014	AL2014	AL6061	AL2014	AL2014	AL6061
	BOLT	STAINLESS STEEL	STAINLESS STEEL	STAINLESS STEEL	SCM-435	STAINLESS STEEL	STAINLESS STEEL	STAINLESS STEEL
LOGO APPLICATION		COLOR DECAL	COLOR DECAL	COLOR DECAL	COLOR DECAL	COLOR DECAL	DECAL/LASER	DECAL/LASER
FINISH		SB BLACK	SB BLACK	SB BLACK	SB BLACK	SB BLACK	SB BLACK	SB BLACK
WEIGHT		242G (L350/Ø27.2)	285G (L350/Ø27.2)	287G (L350/Ø27.2)	355G (L350/Ø27.2)	270G (L300/Ø27.2)	285G (L350/Ø27.2)	305G (L350/Ø27.2)

FORKS		COUGAR	TUX
BIKE TYPE		700C	700C
STEERER		UP 1-1/8" DOWN 1-1/2"	UP 1-1/8" DOWN 1-1/2"
CROWN		57MM	56MM
CROWN RACE		39.8MM	39.8MM
SETBACK		43MM	45MM
MATERIAL		CARBON	CARBON
WEIGHT		475G	400G

SEAT CLAMPS		TIMANIA
MATERIAL		6AL-4V TITANIUM
ID		31.8MM/34.9MM
WEIGHT		20G(34.9MM)

SPACERS		TIMANIA	FALCON
HEIGHT		5/10/15MM	10MM
WEIGHT		2.5/4/7G	10G



MTB



CONTROL
TECH

T I M A N I A



TIMANIA FLAT TOP BAR

ATB-302
 MATERIAL: 3AL-2.5V TITANIUM
 BARBORE Ø: 31.8MM
 WIDTH: 720/760MM
 RISE: 0MM
 BACKSWEEP: 9°
 WEIGHT: 285G (760MM)



TIMANIA FLAT BAR

ATB-257
 MATERIAL: 3AL-2.5V TITANIUM
 BARBORE Ø: 31.8MM
 WIDTH: 660MM
 RISE: 0MM
 BACK SWEEP: 5°
 WEIGHT: 225G (660MM)



TIMANIA FLAT BAR

ATB-305
 MATERIAL: 3AL-2.5V TITANIUM
 BARBORE Ø: 31.8MM
 WIDTH: 720MM
 RISE: 0MM
 BACK SWEEP: 9°
 WEIGHT: 270G (720MM)



TIMANIA RISER BAR

ATB-297
 MATERIAL: 3AL-2.5V TITANIUM
 BARBORE Ø: 31.8MM
 WIDTH: 720/760MM
 RISE: 20MM
 UP SWEEP: 6°
 BACK SWEEP: 9°
 WEIGHT: 255G (720MM)



TIMANIA ±5° STEM

ATB-937
 MATERIAL: 6AL-4V TITANIUM
 HANDLEBAR Ø: 31.8MM
 STEERER Ø: 28.6MM
 LENGTH: 70/90/100/110/120MM
 ANGLE: +/-5°
 WEIGHT: 129G (110MM)

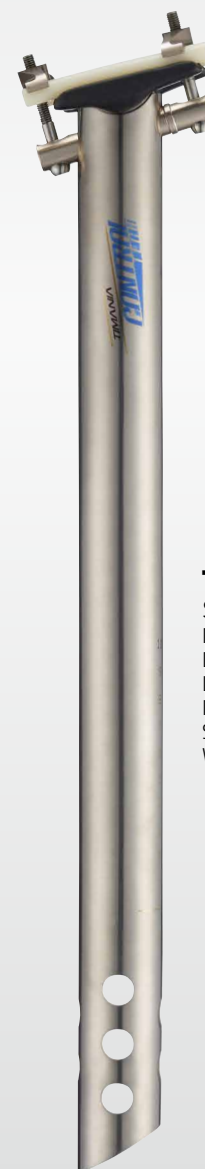

TIMANIA SBO SEATPOST

SP-1190
 MATERIAL: 3AL-2.5V TITANIUM
 DIAMETER Ø: 27.2/31.6MM
 LENGTH: 350/400MM
 MINIMUM INSERT: 90MM(350L), 100MM(400L)
 SETBACK: 0MM
 WEIGHT: 207G (27.2MM, 350L)



TIMANIA STEM CAP

CAP-44
 MATERIAL: TITANIUM
 STEERER Ø: 23.3-25.4
 BOLT: ALUMINUM
 WEIGHT: 34G



TIMANIA SPACERS

HSS-12
 MATERIAL: TITANIUM
 HEIGHT: 5/10/15MM
 WEIGHT: 2/4/7G

TUX



TUX FLAT BAR

ATB-223-8UD
MATERIAL: CARBON FIBER
BARBORE Ø: 31.8MM
WIDTH: 600MM
RISE: 0MM
BACK SWEEP: 6°
WEIGHT: 125G (600MM)
COLOR: RED/GRAY



TUX RISER BAR

ATB-259-8UD
MATERIAL: CARBON FIBER
BARBORE Ø: 31.8MM
WIDTH: 710/760MM
RISE: 20MM
BACK SWEEP: 9°
UP SWEEP: 4°
WEIGHT: 170G (710MM)
COLOR: RED/GRAY



TUX FLAT TOP BAR

ATB-300-8UD
MATERIAL: CARBON FIBER
BARBORE Ø: 31.8MM
WIDTH: 720/760MM
RISE: 0MM
BACK SWEEP: 9°
WEIGHT: 145G (720MM)
COLOR: RED/GRAY



TUX SL FLAT BAR (CROSS COUNTRY ONLY)

ATB-287-8UD
MATERIAL: CARBON FIBER
BARBORE Ø: 31.8MM
WIDTH: 720MM
RISE: 0MM
BACK SWEEP: 9°
WEIGHT: 117G
COLOR: RED/GRAY



TUX SL RISER BAR (CROSS COUNTRY ONLY)

ATB-288-8UD
MATERIAL: CARBON FIBER
BARBORE Ø: 31.8MM
WIDTH: 720MM
RISE: 15MM
BACK SWEEP: 9°
UP SWEEP: 6°
WEIGHT: 125G
COLOR: RED/GRAY



TUX ±5° STEM

RAS-79-FUD
MATERIAL: CARBON FIBER+AL7075
HANDLEBAR Ø: 31.8MM
STEERER Ø: 28.6MM
LENGTH: 70/80/90/100/110/120/130MM
ANGLE: +/- 5°
WEIGHT: 125G (110MM)
COLOR: RED/GRAY

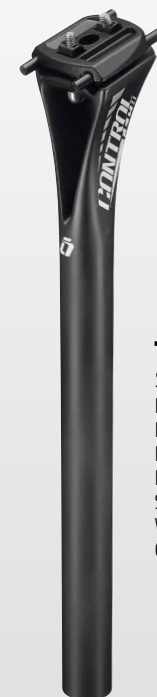

TUX LIGHT SBO SEATPOST

SP-1600
MATERIAL: CARBON FIBER
DIAMETER Ø: 31.6MM
LENGTH: 400MM
MINIMUM INSERT: 100MM
SETBACK: 0MM
WEIGHT: 245G (31.6MM)
COLOR: RED/GRAY



TUX SBO SEATPOST

SP-1620
MATERIAL: CARBON FIBER
DIAMETER Ø: 27.2/31.6MM
LENGTH: 400MM
MINIMUM INSERT: 100MM
SETBACK: 0MM
WEIGHT: 190G (31.6MM)
COLOR: RED/GRAY

EXL



EXL FLAT TOP BAR

ATB-303-8UD
MATERIAL: CARBON FIBER
BARBORE Ø: 31.8MM
WIDTH: 700/760/800MM
BACK SWEEP: 9°
UP SWEEP: 4°
RISE: 0MM
WEIGHT: 174G (760MM)
COLOR: RED/GRAY

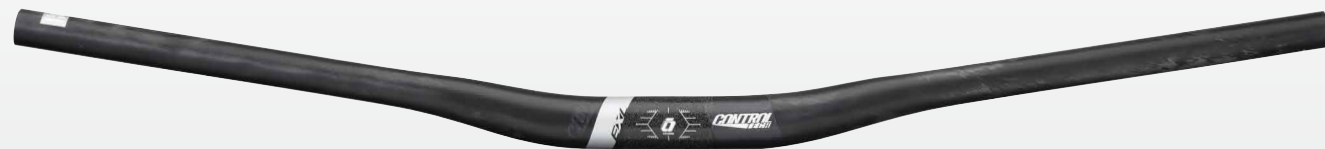

EXL RISER BAR

ATB-304-8UD
MATERIAL: CARBON FIBER
BARBORE Ø: 31.8MM
WIDTH: 710/750/800MM
BACK SWEEP: 9°
UP SWEEP: 4°
RISE: 20MM
WEIGHT: 189G (750MM)
COLOR: RED/GRAY



EXL ±5° STEM

RAS-82-FUD
MATERIAL: CARBON FIBER+AL6061
HANDLEBAR Ø: 31.8MM
STEERER Ø: 28.6MM
LENGTH: 60/70/80/90/100/110/120/130MM
ANGLE: +/- 5°
WEIGHT: 145G (110MM)
COLOR: RED/GRAY



EXL SBO SETATPOST

SP-1270UD
MATERIAL: CARBON FIBER
DIAMETER Ø: 27.2/30.9/31.6MM
LENGTH: 350/400MM
MINIMUM INSERT: 90MM(350L), 100MM(400L)
SETBACK: 0MM
WEIGHT: 207G (27.2MM, 350L)
COLOR: RED/GRAY



EXL SB10 SEATPOST

SP-1280UD
MATERIAL: CARBON FIBER
DIAMETER Ø: 27.2/30.9/31.6MM
LENGTH: 350/400MM
MINIMUM INSERT: 90MM(350L), 100MM(400L)
SETBACK: 10MM
WEIGHT: 227G (27.2MM, 350L)
COLOR: RED/GRAY

SLA



SLA FLAT BAR

ATB-262DB7-8
 MATERIAL: AL7075
 BARBORE Ø: 31.8MM
 WIDTH: 700MM
 BACK SWEEP: 9°
 RISE: 0MM
 WEIGHT: 248G
 COLOR: RED/GRAY



SLA FLAT TOP BAR

ATB-281DB7-8
 MATERIAL: AL7050
 BARBORE Ø: 31.8MM
 WIDTH: 700/760MM
 BACK SWEEP: 9°
 RISE: 0MM
 WEIGHT: 256G (700MM)
 COLOR: RED/GRAY



SLA RISER BAR

ATB-284DB7-8
 MATERIAL: AL7050
 BARBORE Ø: 31.8MM
 WIDTH: 710/750MM
 RISE: 15MM
 BACK SWEEP: 9°
 UP SWEEP: 4°
 WEIGHT: 250G (710MM)
 COLOR: RED/GRAY



SLA ±5° STEM

RAS-85
 MATERIAL: AL7075
 HANDLEBAR Ø: 31.8MM
 STEERER Ø: 28.6MM
 LENGTH: 70/80/90/100/110/120/130MM
 ANGLE: +/- 5°
 WEIGHT: 110G (110MM)
 COLOR: RED/GRAY



SLA SBO SEATPOST

SP-997
 MATERIAL: AL7075
 DIAMETER Ø: 27.2/30.9/31.6MM
 LENGTH: 350/400MM
 MINIMUM INSERT: 90MM(350L), 100MM(400L)
 SETBACK: 0MM
 WEIGHT: 250G (27.2MM, 350L)
 COLOR: RED/GRAY



SLA SB10 SEATPOST

SP-988
 MATERIAL: AL7075
 DIAMETER Ø: 27.2/30.9/31.6MM
 LENGTH: 350/400MM
 MINIMUM INSERT: 90MM(350L), 100MM(400L)
 SETBACK: 10MM
 WEIGHT: 242G (27.2MM, 350L)
 COLOR: RED/GRAY

CLS



CLS FLAT TOP BAR

ATB-281DB6-8
MATERIAL: AL6061
BARBORE Ø: 31.8MM
WIDTH: 700/760MM
RISE: 0MM
BACK SWEEP: 9°
WEIGHT: 268G (700MM)
COLOR: RED/GRAY



CLS RISER BAR

ATB-284DB6-8
MATERIAL: AL6061
BARBORE Ø: 31.8MM
WIDTH: 710/750MM
RISE: 15MM
UP SWEEP: 4°
BACK SWEEP: 9°
WEIGHT: 305G (710MM)
COLOR: RED/GRAY

CLS ±17° DROP STEM

RAS-117
MATERIAL: AL6061
HANDLEBAR Ø: 31.8MM
STEERER Ø: 28.6MM
LENGTH: 70/80/90/100/110/120MM
ANGLE: +/- 17°
WEIGHT: 145G (110MM)
COLOR: RED/GRAY



CLS ±5° STEM

RAS-110
MATERIAL: AL6061
HANDLEBAR Ø: 31.8MM
STEERER Ø: 28.6MM
LENGTH: 60/70/80/90/100/110/120MM
ANGLE: +/- 5°
WEIGHT: 118G (110MM)
COLOR: RED/GRAY



CLS SBO SEATPOST

SP-1420
MATERIAL: AL6061
DIAMETER Ø: 27.2/30.9/31.6MM
LENGTH: 400MM
MINIMUM INSERT: 100MM
SETBACK: 0MM
WEIGHT: 289G (31.6MM)
COLOR: RED/GRAY



CLS SB10 SEATPOST

SP-1180
MATERIAL: AL6061
DIAMETER Ø: 27.2/31.6MM
LENGTH: 350MM
MINIMUM INSERT: 90MM
SETBACK: 10MM
WEIGHT: 285G (27.2MM, 350L)
COLOR: RED/GRAY

LYNX

LYNX 31.8 FLAT TOP BAR

ATB-381DB6 / ATB-381DB6-DI2

MATERIAL: AL6061
BARBORE Ø: 31.8MM
WIDTH: 700/760/800MM
RISE: 0MM
BACK SWEEP: 9°
WEIGHT: 268G (700MM), 307G (760MM DI2)
COLOR: RED/GRAY
COMPATIBLE WITH SHIMANO MTB DI2 SYSTEM



Di2 system

LYNX 35 FLAT TOP BAR

ATB-382DB6-5

MATERIAL: AL6061
BARBORE Ø: 35MM
WIDTH: 710/760/800MM
RISE: 0MM
BACK SWEEP: 9°
WEIGHT: 296G (710MM)
COLOR: RED/GRAY



LYNX 35 RISER BAR

ATB-383DB6-5

MATERIAL: AL6061
BARBORE Ø: 35MM
WIDTH: 750/800MM
RISE: 20MM
UP SWEEP: 4°
BACK SWEEP: 9°
WEIGHT: 310G (750MM)
COLOR: RED/GRAY

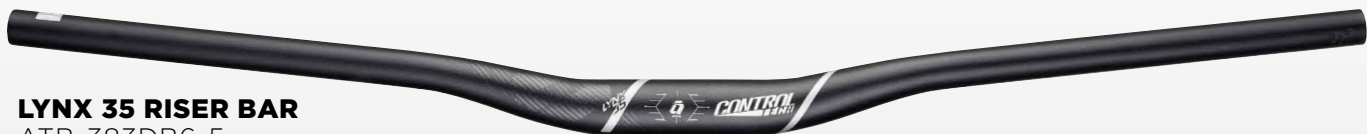

LYNX 31.8 RISER BAR

ATB-384DB6 / ATB-384DB6-DI2

MATERIAL: AL6061
BARBORE Ø: 31.8MM
LENGTH: 710/750/800MM
RISE: 15MM
UP SWEEP: 4°
BACK SWEEP: 9°
WEIGHT: 306G (710MM), 316G (750MM DI2)
COLOR: RED/GRAY
COMPATIBLE WITH SHIMANO MTB DI2 SYSTEM



Di2 system



NEW

LYNX 31.8 EI BAR

ATB-310DB68
MATERIAL: AL6061
BARBORE Ø: 31.8MM
LENGTH: 720/750/760/780/800MM
BACK SWEEP: 9°
WEIGHT: 300G (TBD)(750MM)
COLOR: RED/GRAY



Internal cable tunnel system
With ATB-958 Stem



Di2 system



NEW

LYNX 35 TOP RISER BAR

ATB-311DB65
MATERIAL: AL6061
BARBORE Ø: 35MM
LENGTH: 750/800MM
RISE: 35MM
UP SWEEP: 4°
BACK SWEEP: 9°
WEIGHT: 306G (750MM)
COLOR: RED/GRAY

LYNX SADDLE I

SD-21
SHELL: POLYCARBONATE
RAILS: HOLLOW CHROMOLY
WIDTH: 140MM
LENGTH: 275MM
WEIGHT: 248G
MADE FOR TRAIL, ALL-MOUNTAIN
AND ENDURO



LYNX SADDLE II

SD-23
SHELL: POLYPROPYLENE
RAILS: ALLOY
WIDTH: 145MM
LENGTH: 275MM
WEIGHT: 285G
MADE FOR TRAIL, ALL-MOUNTAIN
AND ENDURO



LYNX PEDAL

PD-04
MATERIAL: AL6061
PLATFORM: 100 X 104MM
WEIGHT: 388G / PAIR
CNC CR-MO AXLE W/ 3 SEALED BEARINGS
COLOR: RED / BLUE / GRAY / BLACK
INTEGRATED THREADLESS PEG DESIGN
IS LIGHTWEIGHT AND RELIABLE



LYNX DROPPER SEATPOST

SP-1530
MATERIAL: AL6066
DIAMETER Ø: 30.9/31.6MM
TRAVEL: 125/150MM
LENGTH: 421MM
MINIMUM INSERT: 87.5MM(125 TRAVEL)
97.5MM(150 TRAVEL)
INSERTION DEPTH: 285MM
WEIGHT: 590G (31.6MM, TRAVEL 125MM)
FEATURE: ENGINEERING PLASTIC REMOTE CONTROL
WITH GIMBALS FOR BETTER ERGONOMICS





NEW Internal cable tunnel system

LYNX -10° DROP STEM

ATB-958
 MATERIAL: AL6061
 HANDLEBAR Ø: 31.8MM
 STEERER Ø: 28.6MM
 LENGTH: 60/70/80/90MM
 ANGLE: -10°
 WEIGHT: 210G (TBD)(70MM)
 COLOR: RED/GRAY



NEW
LYNX 0° DH STEM

ATB-959
LYNX 35 0° DH STEM
 ATB-962
 MATERIAL: AL6061
 HANDLEBAR Ø: 31.8/35MM
 STEERER Ø: 28.6MM
 LENGTH: 40/50MM
 ANGLE: +/-0°
 WEIGHT: 148G (TBD)(31.8, 40MM)
 140G (TBD)(35, 40MM)
 COLOR: LASER



NEW
LYNX 0° DH LIGHT STEM

ATB-961
LYNX 35 0° DH LIGHT STEM
 ATB-963
 MATERIAL: AL6061
 HANDLEBAR Ø: 31.8/35MM
 STEERER Ø: 28.6MM
 LENGTH: 40/50MM
 ANGLE: +/-0°
 WEIGHT: 132G (TBD)(31.8, 40MM)
 123G (TBD)(35, 40MM)
 COLOR: LASER



LYNX -5° DI2 STEM

RAS-96
 MATERIAL: AL6061
 HANDLEBAR Ø: 31.8MM
 STEERER Ø: 28.6MM
 LENGTH: 60/70MM
 ANGLE: -5°
 WEIGHT: 146G (60MM)
 COLOR: RED/GRAY
 FOR ALL MOUNTAIN & ENDURO 27.5 / 29ER.
 COMPATIBLE WITH SHIMANO MTB DI2.

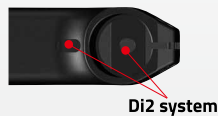

Di2 system



LYNX 0° STEM

ATB-956
 MATERIAL: AL6061
 HANDLEBAR Ø: 31.8MM
 STEERER Ø: 28.6MM
 LENGTH: 40/50MM
 ANGLE: +/-0°
 WEIGHT: 139G (40MM)
 COLOR: RED/GRAY
 IDEAL FOR ALL MOUNTAIN &
 ENDURO 27.5 AND 29ER.



LYNX 35 0° STEM

ATB-957
 MATERIAL: AL6061
 HANDLEBAR Ø: 35MM
 STEERER Ø: 28.6MM
 LENGTH: 40/50MM
 ANGLE: +/-0°
 WEIGHT: 162G (40MM)
 COLOR: RED/GRAY
 IDEAL FOR ALL MOUNTAIN &
 ENDURO 27.5 AND 29ER.

LYNX HUB

HUB-41
 MATERIAL: AL6061
 AXLE MATERIAL: STEEL
 SPOKE HOLES: F/R 32
 FRONT AXLE: 100 X 15MM (2 BEARINGS)
 REAR AXLE: 142 X 12MM (4 BEARINGS)
 WEIGHT: F 199G / R 236G
 DISC FITTING 6-BOLT
 TOOLLESS CASSETTE BODY REMOVAL FOR EASY MAINTENANCE
 COMPATIBLE WITH SHIMANO 115 / SRAM 105 & XD 115



NEW
LYNX HUB

HUB-47
 MATERIAL: AL6061
 AXLE MATERIAL: STEEL
 SPOKE HOLES: F/R 28
 FRONT AXLE: 110 X 15MM (2 BEARINGS)
 REAR AXLE: 148 X 12MM (4 BEARINGS)
 WEIGHT: F 199G / R 236G (TBD)
 DISC FITTING 6-BOLT
 TOOLLESS CASSETTE BODY REMOVAL FOR EASY MAINTENANCE
 COMPATIBLE WITH SHIMANO 115/ SRAM 105 & XD 115
 CONICAL HUBSHELL IS LIGHT, STRONG AND ROBUST FOR OFFLOAD ABUSE



LYNX 27.5ER

RIM-71
LYNX 29ER
 RIM-72
 MATERIAL: AL6061
 FRONT HUB CNC AL6061: 100X15MM, 2 BEARINGS
 REAR HUB CNC AL6061: 142X12MM, 4 BEARINGS
 RIM DEPTH: 21MM
 RIM WIDTH: 24MM
 WEIGHT: 27.5ER 1535G / PAIR, 29ER 1669G / PAIR
 COLOR: RED/GRAY
 TUBELESS READY RIME PROFILE
 SAPIM RACE 2.0/1.8/2.0 DOUBLE BUTTED ROUND SPOKES
 TOOLLESS CASSETTE BODY REMOVAL FOR EASY MAINTENANCE
COMPATIBLE WITH SHIMANO 115/SRAM 105 & XD 115

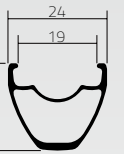

LYNX 27.5 PLUS

RIM-73
 MATERIAL: AL6061
 FRONT HUB CNC AL6061: 110X15MM, 2 BEARINGS
 REAR HUB CNC AL6061: 148X12MM, 4 BEARINGS
 RIM DEPTH: 18MM
 RIM WIDTH: 40MM
 WEIGHT: 1771G / PAIR
 COLOR: RED/GRAY
 TUBELESS READY RIME PROFILE
 SAPIM RACE 2.0/1.8/2.0 DOUBLE BUTTED ROUND SPOKES
 TOOLLESS CASSETTE BODY REMOVAL FOR EASY MAINTENANCE
COMPATIBLE WITH SHIMANO 115/SRAM 105 & XD 115

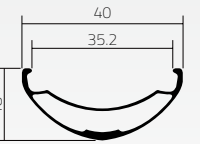

NEW
LYNX CARBON 29ER WIDE

RIM-85
 MATERIAL: CARBON FIBER
 FRONT HUB CNC AL6061: 110X15MM, 28 HOLES, 2 BEARINGS
 REAR HUB CNC AL6061: 148X12MM, 28 HOLES, 4 BEARINGS
 RIM DEPTH: 25MM
 RIM WIDTH: 35MM
 WEIGHT: 1500G / PAIR (TBD)
 COLOR: RED/GRAY
 TUBELESS READY RIME PROFILE
 TOOLLESS CASSETTE BODY REMOVAL FOR EASY MAINTENANCE
COMPATIBLE WITH SHIMANO 115/SRAM 105 & XD 115

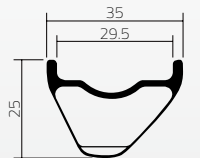

NEW
LYNX 29ER WIDE

RIM-86
 MATERIAL: AL6061
 FRONT HUB CNC AL6061: 110X15MM, 28 HOLES, 2 BEARINGS
 REAR HUB CNC AL6061: 148X12MM, 28 HOLES, 4 BEARINGS
 RIM DEPTH: 19MM
 RIM WIDTH: 32MM
 WEIGHT: 1600G / PAIR (TBD)
 COLOR: RED/GRAY
 TUBELESS READY RIME PROFILE
 TOOLLESS CASSETTE BODY REMOVAL FOR EASY MAINTENANCE
COMPATIBLE WITH SHIMANO 115/SRAM 105 & XD 115

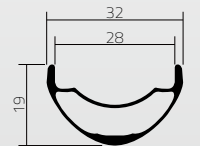

M S T



MST 35 FLAT TOP BAR

ATB-308/DI2
MATERIAL: CARBON FIBER
BARBORE Ø: 35.0MM
LENGTH: 710/760/800MM
BACK SWEEP: 9°
UP SWEEP: 0
RISE: 0
WEIGHT: 215G (760MM)
COLOR: RED/GRAY



MST 35 RISER HANDLEBAR

ATB-283DB6-5 / ATB-283DB7-5
MATERIAL: AL6061/AL7050
BARBORE Ø: 35.0MM
LENGTH: 750/800MM
BACK SWEEP: 9°
UP SWEEP: 4°
RISE: 20MM
WEIGHT: 310G (AL6061, 750MM) / 276G (AL7050, 750MM)
COLOR: RED/GRAY



MST 35 RISER

ATB-309
MATERIAL: CARBON FIBER
BARBORE Ø: 35.0MM
LENGTH: 750/800MM
BACK SWEEP: 9°
UP SWEEP: 4°
RISE: 20MM
WEIGHT: 235G (750MM)
COLOR: RED/GRAY



MST 35 ALLOY FLAT TOP HANDLEBAR

ATB-282DB6-5 / ATB-282DB7-5
MATERIAL: AL6061/AL7075
BARBORE Ø: 35.0MM
LENGTH: 710/760/800MM
BACK SWEEP: 9°
WEIGHT: 296G (AL6061, 710MM) / 264G (AL7050, 710MM)
COLOR: RED/GRAY



MST 35 0° STEM

ATB-949
MATERIAL: AL6061
HANDLEBAR Ø: 35.0MM
STEERER Ø: 28.6MM
LENGTH: 50/60/70/80MM
ANGLE: +/- 0°
WEIGHT: 146G (60MM)
COLOR: RED/GRAY



MST SBO SEATPOST

SP-1220
MATERIAL: AL7050/AL6061
DIAMETER Ø: 27.2/30.9/31.6MM
LENGTH: 400MM
MINIMUM INSERT: 100MM
WEIGHT: AL7050 255G (31.6MM, 400L)
AL6061 289G (31.6MM, 400L)

ONE



ONE FLAT BAR

ATB-210DB6-8
MATERIAL: AL6061
BARBORE Ø: 31.8MM
WIDTH: 600/700/760MM
BACK SWEEP: 6° (600MM)
BACK SWEEP: 9° (700/760MM)
WEIGHT: 244G (700MM)
COLOR: DECAL/LASER

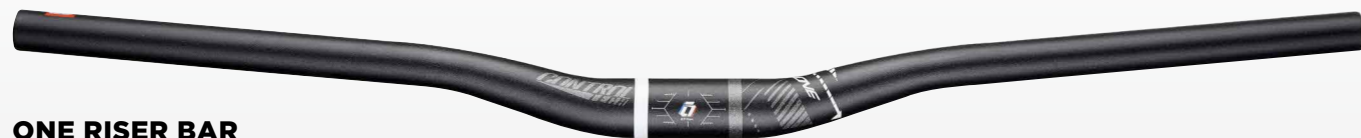

ONE RISER BAR

ATB-213DB6-8
MATERIAL: AL6061
BARBORE Ø: 31.8MM
WIDTH: 660/700MM
RISE: 20MM
UP SWEEP: 6°(660MM), 5° (700MM)
BACK SWEEP: 6° (660MM), 9° (700MM)
WEIGHT: 293G (660MM)
COLOR: DECAL/LASER

ONE ±17° DROP STEM

RAS-217
MATERIAL: AL6061
HANDLEBAR Ø: 31.8MM
STEERER Ø: 28.6MM
LENGTH: 70/80/90/100/110/120MM
ANGLE: +/- 17°
WEIGHT: 145G (110MM)
COLOR: DECAL/LASER



ONE SB10 SEATPOST

SP-1080
MATERIAL: AL6061
DIAMETER Ø: 27.2/30.9/31.6MM
LENGTH: 350/400MM
MINIMUM INSERT: 90MM(350L), 100MM(400L)
SETBACK: 10MM
WEIGHT: 285G (27.2MM, 350L)
COLOR: DECAL/LASER



ONE ±5° STEM

RAS-80
MATERIAL: AL6061
HANDLEBAR Ø: 31.8MM
STEERER Ø: 28.6MM
LENGTH: 60/70/80/90/100/110/120/130MM
ANGLE: +/- 5°
WEIGHT: 137G (110MM)
COLOR: DECAL/LASER



OE RISER BAR

ATB-306
MATERIAL: AL6061
BARBORE Ø: 31.8MM
WIDTH: 620/700/750MM
RISE: 15MM
BACK SWEEP: 9°
WEIGHT: 326G (750MM)



OE FLAT BAR

ATB-307
MATERIAL: AL6061
BARBORE Ø: 31.8MM
WIDTH: 650/700/750/780MM
WEIGHT: 295G (750MM)

OE ±5° STEM

RAS-99
MATERIAL: AL6061
HANDLEBAR Ø: 31.8MM
STEERER Ø: 28.6MM
LENGTH: 60/70/80/90/100/110/120MM
ANGLE: +/-5°
WEIGHT: 137G(110MM)



OE SB10 SEATPOST

SP-1640
MATERIAL: AL6061
DIAMETER Ø: 27.2/30.9/31.6MM
LENGTH: 350/400MM
MINIMUM INSERT: 90MM(350L), 100MM(400L)
SETBACK: 10MM
WEIGHT: 305G (27.2MM, 350L)

MTB COLLECTION SPEC

| WHEELS

	LYNX 27.5	LYNX 29	LYNX 27.5+	LYNX 29 CARBON WIDE	LYNX 29 WIDE
HUB	F:100x15mm R:142x12mm	F:100x15mm R:142x12mm	F:110x15mm R:148x12mm	F:110x15mm R:148x12mm	F:110x15mm R:148x12mm
RIM DEPTH	21MM	21MM	18MM	25MM	19MM
RIM WIDTH	24MM	24MM	40MM	35MM	32MM
WEIGHT	1535G	1669G	1771G	1500G (TBD)	1600G (TBD)

| SEAT CLAMPS

	TIMANIA
MATERIAL	6AL-4V TITANIUM
ID	31.8MM/34.9MM
WEIGHT	20G(34.9MM)

| SPACERS

	TIMANIA
HEIGHT	5/10/15MM
WEIGHT	2/4/7G

| PEDALS

	LYNX
SIZE	100x104mm
MATERIAL	AL6061 CNC
BEARING	3 SEALED BEARINGS
AXLE	CR-MO CNC
WEIGHT	388G/PR

| HUB

	LYNX	LYNX WIDE
HUB	F:100x15mm / R:142x12mm 32 HOLES F & R	F:110x15mm / R:148x12mm 28 HOLES F & R
MATERIAL	AL6061	AL6061
WEIGHT	F:199G / R:236G	F:199G / R:236G (TBD)

| STEM

	TIMANIA	TUX	EXL	SLA	CLS	CLS DROP	LYNX 35	LYNX 31.8	LYNX Di2	LYNX DROP	LYNX DH
ANGLE	±5°	±5°	±5°	±5°	±5°	±17°	±0°	±0°	-5°	-10°	±0°
40							V	V			V
45											
50							V	V			V
60			V		V				V	V	
70	V	V	V	V	V	V			V	V	
80		V	V	V	V	V				V	
90	V	V	V	V	V	V				V	
100	V	V	V	V	V	V					
110	V	V	V	V	V	V					
120	V	V	V	V	V	V					
130		V	V	V							
STACK HEIGHT(MM)	40	40	40	40	40	40	43	41	35	39	47.5
STEERER Ø(MM)	28.6	28.6	28.6	28.6	28.6	28.6	28.6	28.6	28.6	28.6	28.6
BARBORE Ø(MM)	31.8	31.8	31.8	31.8	31.8	31.8	35	31.8	31.8	31.8	31.8/35
BODY	MONOCOQUE TITANIUM	AL7075+ CARBON	AL6061+ CARBON	AL7075	AL6061	AL6061	AL6061	AL6061	AL6061	AL6061	AL6061
FACEPLATE	6AL-4V TITANIUM	AL7075+ CARBON	AL6061	AL7075	AL6061	AL6061	AL6061	AL6061	AL6061	AL6061	AL6061
BOLT	6AL-4V TITANIUM	STAINLESS STEEL	SCM-435	STAINLESS STEEL	SCM-435	SCM-435	SCM-435	SCM-435	SCM-435	SCM-435	SCM-435
LOGO APPLICATION	LASER	COLOR DECAL	COLOR DECAL	COLOR DECAL	COLOR DECAL	COLOR DECAL	COLOR DECAL	COLOR DECAL	COLOR DECAL	COLOR DECAL	COLOR DECAL
FINISH	TITANIUM	CARBON	CARBON	SB BLACK	SB BLACK	SB BLACK	SB BLACK	SB BLACK	SB BLACK	SB BLACK	SB BLACK
WEIGHT	129G (110MM)	125G (110MM)	145G (110MM)	110G (110MM)	118G (110MM)	145G (110MM)	162G (40MM)	139G (40MM)	146G (60MM)	210G TBD(70MM)	148G(31.8/L40) 140G(35/L40) TBD

| STEM

	LYNX DH LIGHT	MST	ONE	ONE DROP	OE
ANGLE	±0°	±0°	±5°	±17°	±5°
40	V				
45					
50	V	V			
60		V	V	V	V
70		V	V	V	V
80		V	V	V	V
90			V	V	V
100			V	V	V
110			V	V	V
120			V	V	V
130			V		
STACK HEIGHT(MM)	47.5	42	40	40	40
STEERER Ø(MM)	28.6	28.6	28.6	28.6	28.6
BARBORE Ø(MM)	31.8/35	35	31.8	31.8	31.8
BODY	AL6061	AL6061	AL6061	AL6061	AL6061
FACEPLATE	AL6061	AL6061	AL6061	AL6061	AL6061
BOLT	SCM-435	STAINLESS STEEL	SCM-435	SCM-435	SCM-435
LOGO APPLICATION	COLOR DECAL	COLOR DECAL	DECAL/LASER	DECAL/LASER	LASER
FINISH	SB BLACK	SB BLACK	SB BLACK	SB BLACK	SB BLACK
WEIGHT	132G(31.8/L40) 123G(35/L40) TBD	146G (60MM)	137G (110MM)	145G (110MM)	137G (110MM)

MTB BARS

	TIMANIA FLAT TOP	TIMANIA FLAT	TIMANIA FLAT	TIMANIA RISER	TUX FLAT	TUX RISER	TUX FLAT TOP	TUX SL FLAT	TUX SL RISER	EXL FLAT TOP	EXL RISER	SLA FLAT	SLA FLAT TOP	SLA RISER	CLS FLAT TOP	CLS RISER
BARBORE	31.8	31.8	31.8	31.8	31.8	31.8	31.8	31.8	31.8	31.8	31.8	31.8	31.8	31.8	31.8	31.8
600					V											
620																
640																
650																
660		V														
680																
690																
700										V		V	V		V	
710						V					V			V		V
720	V		V	V				V	V	V						
750											V			V		V
760	V			V		V				V			V		V	
780																
800								V	V							
BACK SWEEP	9°	5°	9°	9°	6°	9°	9°	9°	9°	9°	9°	9°	9°	9°	9°	9°
UP SWEEP	0°	0°	0°	6°	0°	4°	0°	0°	6°	4°	4°	0°	0°	4°	0°	4°
RISE(MM)	0	0	0	20	0	20	0	0	15	0	20	0	0	15	0	15
MATERIAL	3AL-2.5V TITANIUM	3AL-2.5V TITANIUM	3AL-2.5V TITANIUM	3AL-2.5V TITANIUM	CARBON	CARBON	CARBON	CARBON	CARBON	CARBON	CARBON	AL7075	AL7050	AL7050	AL6061	AL6061
LOGO APPLICATION	LASER	LASER	LASER	LASER	COLOR DECAL	COLOR DECAL	COLOR DECAL	COLOR DECAL	COLOR DECAL	COLOR DECAL	COLOR DECAL	COLOR DECAL	COLOR DECAL	COLOR DECAL	COLOR DECAL	COLOR DECAL
FINISH	TITANIUM	TITANIUM	TITANIUM	TITANIUM	CARBON	CARBON	CARBON	CARBON	CARBON	CARBON	CARBON	SB BLACK	SB BLACK	SB BLACK	SB BLACK	SB BLACK
WEIGHT	285 (760MM)	225G (660MM)	270G (720MM)	255G (720MM)	125G (600MM)	170G (710MM)	145G (720MM)	117G	125G	174G (760MM)	189G (750MM)	248G	256G (700MM)	250G (710MM)	268G (700MM)	305G (710MM)
	LYNX 35 FLAT TOP	LYNX 35 RISER	LYNX 31.8 FLAT TOP	LYNX 31.8 RISER	LYNX 35 TOP RISER	LYNX 31.8 EI	MST 35 FLAT TOP	MST 35 RISER	MST 35 AL FLAT TOP	MST 35 AL RISER	ONE FLAT	ONE RISER	OE RISER	OE FLAT		
BARBORE	35	35	31.8	31.8	35	31.8	35	35	35	35	31.8	31.8	31.8	31.8		
600											V					
620														V		
640																
650																V
660													V			
680																
690																
700				V								V	V	V	V	
710	V				V			V		V						
720									V							
750		V			V	V	V		V					V	V	
760	V		V					V	V				V			
780									V							
800	V	V	V	V	V	V	V	V	V	V						V
BACK SWEEP	9°	9°	9°	9°	9°	9°	9°	9°	9°	9°	9°	9°	9°	9°	0°	0°
UP SWEEP	0°	4°	0°	4°	4°	0°	0°	4°	0°	4°	0°	6°(W660) 5°(W700)	6°(W660) 9°(W700)	0°	0°	0°
RISE(MM)	0	20	0	15	35	0	0	20	0	20	0	20	15	0	0	0
MATERIAL	AL6061	AL6061	AL6061	AL6061	AL6061	AL6061	CARBON	CARBON	AL7050 AL6061	AL7050 AL6061	AL6061	AL6061	AL6061	AL6061	AL6061	AL6061
LOGO APPLICATION	COLOR DECAL	COLOR DECAL	COLOR DECAL	COLOR DECAL	COLOR DECAL	COLOR DECAL	COLOR DECAL	COLOR DECAL	COLOR DECAL	COLOR DECAL	DECAL LASER	DECAL LASER	LASER	LASER		
FINISH	SB BLACK	SB BLACK	SB BLACK	SB BLACK	SB BLACK	SB BLACK	CARBON	CARBON	SB BLACK	SB BLACK	SB BLACK	SB BLACK	SB BLACK	SB BLACK	SB BLACK	SB BLACK
WEIGHT	296G (710MM)	310G (750MM)	NON D12 268G (700MM) D12 307G (760MM)	NON D12 306G (710MM) D12 316G (750MM)	306G (750MM)	306G (750MM)	215G (760MM)	235G (750MM)	264G (710MM) AL6061 296G (710MM)	276G (750MM) AL6061 310G (750MM)	244G (700MM)	293G (660MM)	326G (750MM)	295G (750MM)		

SEATPOST

	TIMANIA SBO	TUX LIGHT SBO	TUX SBO	EXL SBO	EXL SB10	SLA SBO	SLA SB10	CLS SBO	CLS SB10	LYNX DROPPER	
LENGTH (MM)	250										
	300										
	350	V			V	V	V			V	
	400	V	V	V	V	V	V	V			
	410										
	421									V	
DIAMETER (MM)	27.2	V		V	V	V	V	V	V		
	30.9				V	V	V	V		V	
	31.6	V	V	V	V	V	V	V	V	V	
TRAVEL(MM)	0	0	0	0	0	0	0	0	0	125/150	
SETBACK(MM)	0	0	0	0	0	0	10	0	10	0	
MATERIAL	TUBE	3AL-2.5V TITANIUM	CARBON	CARBON	CARBON	CARBON	AL7075	AL7075	AL6061	AL6061	AL6066
	CLAMP	CARBON	AL6066	AL2014	AL2014	AL2014	AL2014	AL2014	AL2014	AL2014	AL6066
	BOLT	6AL-4V TITANIUM	STAINLESS STEEL	STAINLESS STEEL	STAINLESS STEEL	STAINLESS STEEL	STAINLESS STEEL	STAINLESS STEEL	STAINLESS STEEL	STAINLESS STEEL	SCM-435
LOGO APPLICATION	LASER	COLOR DECAL	COLOR DECAL	COLOR DECAL	COLOR DECAL	COLOR DECAL	COLOR DECAL	COLOR DECAL	COLOR DECAL	COLOR DECAL	LASER
FINISH	TITANIUM	CARBON	CARBON	UD	UD	SB BLACK	SB BLACK	SB BLACK	SB BLACK	SB BLACK	SB BLACK
WEIGHT	204G (L350/Ø27.2)	245G (L400/Ø31.6)	190G (L400/Ø31.6)	207G (L350/Ø27.2)	227G (L350/Ø27.2)	250G (L350/Ø27.2)	242G (L350/Ø27.2)	289G (L400/Ø31.6)	285G (L350/Ø27.2)	590G (TRAVEL 125 Ø31.6)	

SEATPOST

	MST	ONE SB10	OE SB10	
LENGTH (MM)	250			
	300			
	350			
	400	V	V	
	410			
	421			
DIAMETER (MM)	27.2	V	V	
	30.9	V	V	
	31.6	V	V	
	TRAVEL(MM)	0	0	0
SETBACK(MM)	0	10	10	
MATERIAL	TUBE	AL7050 AL6061	AL6061	AL6061
	CLAMP	AL2014	AL2014	AL6061
	BOLT	STAINLESS STEEL	STAINLESS STEEL	STAINLESS STEEL
LOGO APPLICATION	COLOR DECAL	DECAL/LASER	DECAL/LASER	
FINISH	SB BLACK	SB BLACK	SB BLACK	
WEIGHT	AL7050 255G (L400/Ø31.6) AL6061 289G (L400/Ø31.6)	285G (L350/Ø27.2)	305G (L350/Ø27.2)	

TT

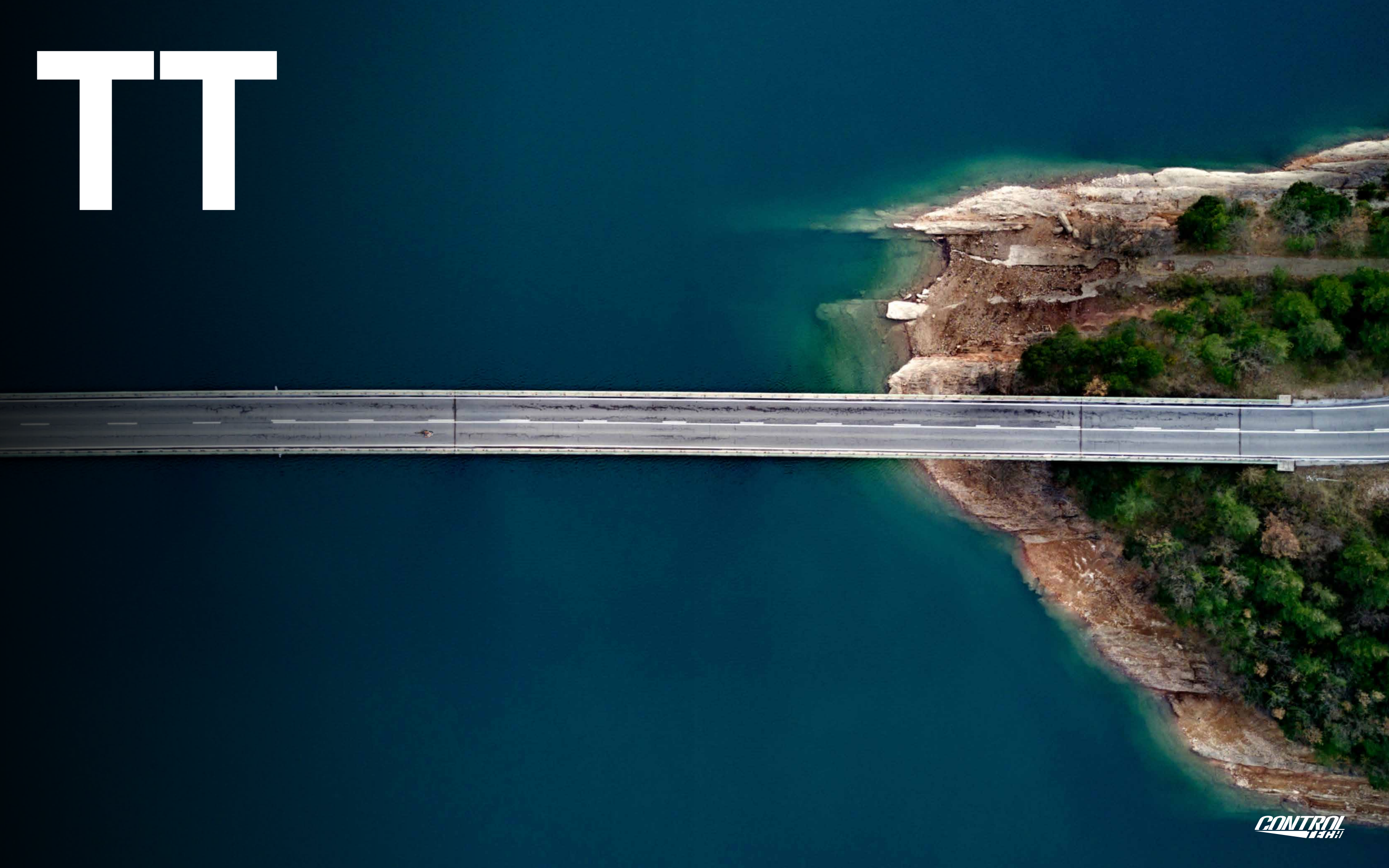

CONTROL
1971

TT / TRI

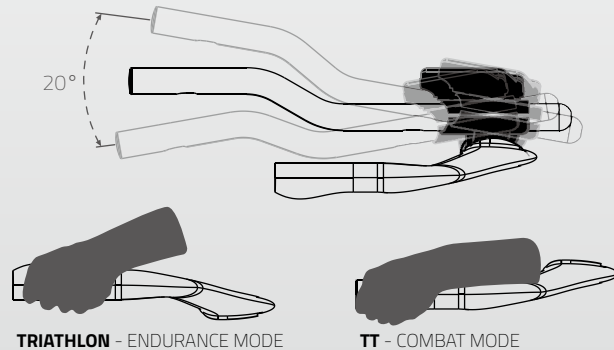
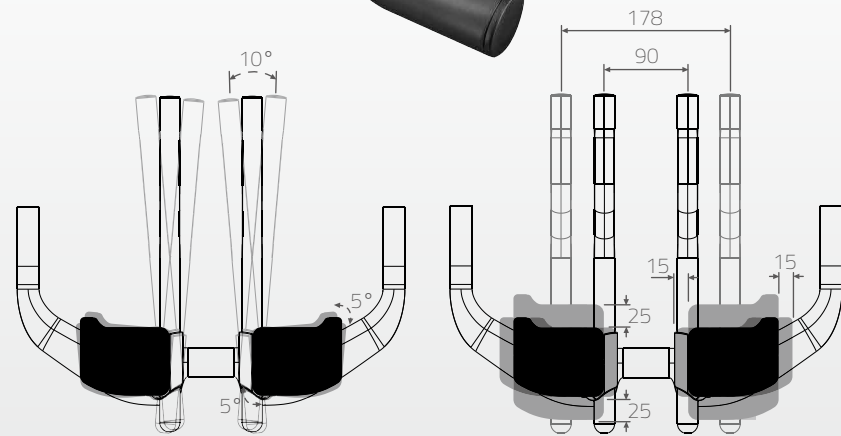

TRIATHLON - ENDURANCE MODE TT - COMBAT MODE

SMART BAR GRIP

TIME ZONE TT AEROBAR

TTH-17
 MATERIAL: UD CARBON
 WIDTH: 400MM
 EXTENSION BAR RISE: 30MM
 LENGTH: MAX. 300MM(C TO TOP), MIN. 240MM
 EXTENSION BAR: S BAR, UP / DOWN ANGLE: 20°
 EXTENSION BAR: S BAR, R / L ANGLE: 10°
 ARMRESTS R / L ADJUSTABLE : R/30MM, L/30MM
 ARMRESTS F / B ADJUSTABLE : F/50MM, B/50MM
 ARMREST'S + / - ADJUSTABLE ANGLE: 10°(+/-5°)
 OPTION SPACERS: 20MM OR 40MM OR 60MM(20+40MM)
 WEIGHT: 680G (MIN STACK)
 COLOR: RED/GRAY

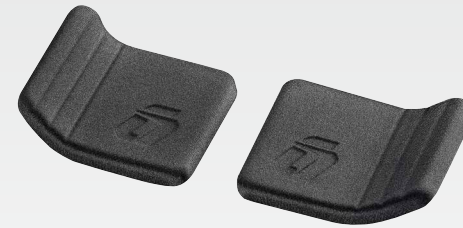

TIME ZONE AEROBAR PAD

TTH-17P
 MATERIAL: LYCRA+EVA
 WEIGHT: 12G / PAIR
 ELBOW PAD OF TIME ZONE AEROBAR



TIME ZONE AEROBAR SPACER KIT

TTH-1761M
 MATERIAL: AL6061
 WEIGHT: 345G / SET
 20MM SPACER/40MM SPACER/BRIDGE AND BOLTS
 FOR 20MM/40MM/60MM SPACERS ARE INCLUDED



FRONT

REVERSE



TIME ZONE TRI AEROBAR

TTH-18
 MATERIAL: UD CARBON
 WIDTH: 400MM
 EXTENSION BAR ANGLE: 34°
 LENGTH: MAX. 300MM(C TO TOP) , MIN. 240MM
 EXTENSION BAR: J BAR, UP / DOWN ANGLE: 20°
 EXTENSION BAR: J BAR, R / L ANGLE: 10°
 ARMRESTS R / L ADJUSTABLE : R/30MM, L/30MM
 ARMRESTS F / B ADJUSTABLE : F/50MM, B/50MM
 ARMREST'S + / - ADJUSTABLE ANGLE: 10°(+/-5°)
 OPTION SPACERS:20MM, 40MM OR 60MM (20+40MM)
 WEIGHT: 690G (MIN STACK)
 COLOR: RED/GRAY



IMPEL MINI CLIP-ON

TTH-13
 MATERIAL: CARBON
 CLAMP Ø: 31.8MM
 LENGTH: 168MM
 OPTION SPACERS: 30MM
 WEIGHT: 225G
 COLOR: RED/GRAY



IMPEL PAD

TTH-13P
 MATERIAL: LYCRA+EVA
 WEIGHT: 96G / PAIR



IMPEL SPACER

TTH-13M
 MATERIAL: AL6061
 HEIGHT: 30MM
 WEIGHT: 96G / SET



SIROCCO MINI CLIP-ON

TTH-19
 MATERIAL: UD CARBON
 LENGTH: MAX 213MM
 EXTENTION BAR ANGLE: 45°
 HANDLEBAR MOUNTED Ø: 31.8MM
 ARMRESTS F / B ADJUSTABLE : 46MM
 WEIGHT: 370G(WITH C CLAMP)
 377G(WITH ROUND CLAMP)
 362G(WITH SQURE CLAMP)
 STEM MOUNTED FOR ITU COMPLIANCE



TTH-19-1



Handlebar Mounted



TTH-19-2

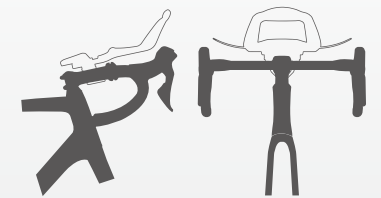

Stem Mounted



SIROCCO ADAPTOR KIT (HANDLEBAR-MOUNTED)

TTH-1961C
 MATERIAL: AL6061
 CLAMP Ø: 31.8MM
 WEIGHT: 99G / SET

SIROCCO ADAPTOR KIT (STEM-MOUNTED)

TTH-1961S
 MATERIAL: AL6061
 WEIGHT: 91G / SET (ROUND STEN MOUNTED)
 106.5G / SET (ROUND STEN MOUNTED)

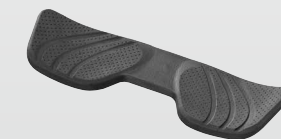

SIRCCO PAD

TTH-19P
 MATERIAL: PLUS FOAM
 WEIGHT: 20G



TT CARBON EXTENSION S BEND

TTH-25
 MATERIAL: CARBON
 CLAMP Ø: 31.8MM
 EXTENSION BAR RISE: 30MM
 LENGTH: MAX. 300MM(C TO TOP) , MIN. 240MM
 ARMRESTS R / L ADJUSTABLE : R/30MM, L/30MM
 ARMRESTS F / B ADJUSTABLE : F/50MM, B/50MM
 ARMREST'S + / - ADJUSTABLE ANGLE: 10°(+/-5°)
 OPTION SPACERS: 20/40MM/60MM
 WEIGHT: 420G
 COLOR: GLOSSY/MATTE



TRI CARBON EXTENSION J BEND

TTH-26
 MATERIAL: CARBON
 CLAMP Ø: 31.8MM
 EXTENSION BAR ANGLE: 34°
 LENGTH: MAX. 300MM(C TO TOP) , MIN. 240MM
 ARMRESTS R / L ADJUSTABLE : R/30MM, L/30MM
 ARMRESTS F / B ADJUSTABLE : F/50MM, B/50MM
 ARMREST'S + / - ADJUSTABLE ANGLE: 10°(+/-5°)
 OPTION SPACERS: 20/40MM/60MM
 WEIGHT: 430G
 COLOR: GLOSSY/MATTE



FALCON TT ALLOY EXTENSION S BEND

TTH-15
 MATERIAL: AL6061
 CLAMP Ø: 31.8MM
 EXTENSION BAR RISE: 29MM
 LENGTH: MAX 303MM(C TO TOP), MIN 253MM
 ARMRESTS R / L ADJUSTABLE : R/30MM, L/30MM
 ARMRESTS F / B ADJUSTABLE : F/50MM, B/50MM
 ARMREST'S + / - ADJUSTABLE ANGLE: 10°(+/-5°)
 OPTION SPACERS: 20/40/60MM
 WEIGHT: 450G (WITH PADS)
 COLOR: RED/GRAY



FALCON TRI ALLOY EXTENSION J BEND

TTH-16
 MATERIAL: AL6061
 CLAMP Ø: 31.8MM
 EXTENSION BAR ANGLE: 40°
 LENGTH: MAX 303MM(C TO TOP), MIN 253MM
 ARMRESTS R / L ADJUSTABLE : R/30MM, L/30MM
 ARMRESTS F / B ADJUSTABLE : F/50MM, B/50MM
 ARMREST'S + / - ADJUSTABLE ANGLE: 10°(+/-5°)
 OPTION SPACERS: 20/40/60MM
 WEIGHT: 462G (WITH PADS)
 COLOR: RED/GRAY



TIME ZONE HYDRATION SYSTEM

THS-01
 MATERIAL: HDPE+PA66-GF30
 CAPACITY: 800ML
 SIZE: L262 X W71 X H191MM
 WIDTH: 90MM TO 120MM (CENTER TO CENTER)
 WEIGHT: 396G
 COMPATIBLE WITH GARMIN AND GO PRO

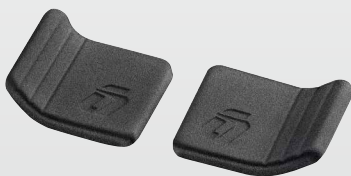

TIME ZONE AEROBAR PAD

TTH-17P
 MATERIAL: LYCRA+EVA
 WEIGHT: 12G / PAIR



ARMREST STACK SPACER KIT 20MM

TTH-15M
 MATERIAL: AL6061
 HEIGHT: 20MM
 WEIGHT: 90G / SET



ARMREST STACK SPACER KIT 40MM

TTH-15M
 MATERIAL: AL6061
 HEIGHT: 40MM
 WEIGHT: 158G / SET



ARMREST STACK SPACER KIT 60MM

TTH-15M
 MATERIAL: AL6061
 HEIGHT: 60MM
 WEIGHT: 226G / SET



FALCON REAR HYDRATION SYSTEMS

BC-31
 MATERIAL: AL6061+PLASTIC
 CAPACITY: 2 OR 1 BOTTLES / 1 CO2 CANISTER
 ADJUSTMENT: ANGLE UP TO 45°, UP TO 30MM
 WEIGHT: 202G
 COLOR: RED/GRAY



TRI-POWER UNIT

BAG-01
 MATERIAL: TPV+ABS
 SIZE: L220 X W42 X H66MM
 CAPACITY: 260CM³
 WEIGHT: 130G



TT ALLOY LEVER

TTL-02
 MATERIAL: AL6061
 SIZE: L126 X W18.7 X H70.8MM
 INNER Ø: 20MM
 WEIGHT: 170G / PAIR



TT CARBON LEVER

TTL-01
 MATERIAL: 3K CARBON
 SIZE: L110 X W15 X H81MM
 INNER Ø: 20MM
 WEIGHT: 124G / PAIR

NEW CARBON TRACK HANDLEBAR

RA-548
 MATERIAL: CARBON FIBER
 WIDTH: 340/350/360/380/400MM
 REACH: 110MM
 DROP: 149MM
 BARBORE Ø: 31.8MM
 GRIP DIAMETER Ø: 26MM
 WEIGHT: 350G (360MM)



BULL HORN CARBON BASEBAR

RA-508-8
 MATERIAL: 3K CARBON
 BARBORE Ø: 31.8MM
 WIDTH: 400M
 WEIGHT: 158G
 COLOR: RED/GRAY



BULL HORN ALLOY BASEBAR

RA-499DB7-8
 MATERIAL: AL7075
 BARBORE Ø: 31.8MM
 WIDTH: 400M
 WEIGHT: 260G
 COLOR: RED/GRAY



NEW COUGAR AERO BASEBAR

RA-547
 MATERIAL: AL6061
 WIDTH: 400/420/440MM
 BARBORE Ø: 31.8MM
 WEIGHT: 319G (420MM)
 UCI COMPLIANT 3:1
 AERODYNAMIC



TT COLLECTION SPEC

TT BAR

	TIME ZONE TT AERO S BEND	TIME ZONE TRI AERO J BEND	IMPEL MINI CLIP ON	SIROCCO MINI CLIP ON	TT CARBON S BEND	TRI CARBON J BEND	FALCON TT S BEND	FALCON TT J BEND
CLAMP Ø	31.8	31.8	31.8	31.8 / STEM	31.8	31.8	31.8	31.8
HANDLE ADJUSTMENT(MM)	-	-	-	-	-	-	-	-
PAD HOLDER ADJUSTMENT(MM)	L 30 F 50 R 30 B 50	L 30 F 50 R 30 B 50	-	F 46 B 46	L 30 R 30	L 30 R 30	L 30 R 30	L 30 R 30
PAD HOLDER ANGLE	L / R 10°(+/- 5°)	L / R 10°(+/- 5°)	-	-	L / R 15°(+/- 7.5°)	L / R 15°(+/- 7.5°)	L / R 15°(+/- 7.5°)	L / R 15°(+/- 7.5°)
CLAMP ADJUSTMENT(MM)	-	-	-	-	-	-	-	-
WING WIDTH(MM)	400	400	-	-	-	-	-	-
EXTENSION LENGTH(MM)	MAX 300 MIN 240	MAX 300 MIN 240	168	213	MAX 300 MIN 240	MAX 300 MIN 240	MAX 303 MIN 253	MAX 303 MIN 253
EXTENSION BAR ANGLE	-	34°	-	45°	-	34°	-	40°
EXTENSION ADJUSTMENT ANGLE	+ / - 20° L / R 10°	+ / - 20° L / R 10°	-	-	-	-	-	-
EXTENSION BAR RISE(C TO C)	30	-	-	-	20	-	28	-
OPTION SPACERS(MM)	20/40/60	20/40/60	30	-	20/40/60	20/40/60	20/40/60	20/40/60
LOGO APPLICATION	COLOR DECAL	COLOR DECAL	COLOR DECAL	COLOR DECAL	COLOR DECAL	COLOR DECAL	COLOR DECAL	COLOR DECAL
FINISH	MATT BLACK SHINY BLACK	MATT BLACK SHINY BLACK	MATT BLACK SHINY BLACK	MATT BLACK	MATT BLACK SHINY BLACK	MATT BLACK SHINY BLACK	SB BLACK	SB BLACK
MATERIAL	UD CARBON	UD CARBON	UD CARBON	UD CARBON	UD CARBON	UD CARBON	AL6061	AL6061
BOLTS	STAINLESS STEEL	STAINLESS STEEL	SCM-435	STAINLESS STEEL	STAINLESS STEEL	STAINLESS STEEL	SCM-435	SCM-435
WEIGHT	680G	690G	225G	370G(C Clamp) 377G(Round clamp) 362G(Square clamp)	420G	430G	450G	462G

BASEBAR

	BULL HORN CARBON	BULL HORN ALLOY	AERO ALLOY BASEBAR
BARBORE	31.8	31.8	31.8
WIDTH(MM)	400	400	400/420/440
CABLE ROUTING	GROOVES	GROOVES	GROOVES
FINISH	3K CARBON	SB BLACK	SB BLACK
MATERIAL	CARBON	AL7075	AL6061
WEIGHT	158G	260G	319G(420mm)

TT LEVER

	LEVER	LEVER
BODY MATERIAL	3K CARBON	AL6061
SIZE(MM)	L 110 X W 15 X H 81	L 126 X W 18.7 X H 70.8
INNER Ø(MM)	20	20
WEIGHT	124G / PAIR	170G / PAIR



NON SERIES

E-I ±5° STEM

ST-EB-01
 MATERIAL: AL6061
 HANDLEBAR Ø: 31.8
 STEERER Ø: 28.6
 LENGTH: 80/90/100/110MM
 ANGLE: +/- 5°
 WEIGHT: 245G (110MM)
 COMPATIBLE WITH BOSCH KIOX CRADLE



E-I ADJUSTABLE STEM

ST-EB-02
 MATERIAL: AL6061
 HANDLEBAR Ø: 31.8
 STEERER Ø: 28.6
 LENGTH: 90/100/110/120MM
 ANGLE: +25° ~ -30°
 WEIGHT: 370G (110MM)
 INTEGRATED WITH BOSCH KIOX DISPLAY



NEW

±40° DROP STEM

RAS-104
 MATERIAL: AL6061
 HANDLEBAR Ø: 31.8MM
 STEERER Ø: 28.6MM
 ANGLE: ±40°
 LENGTH: 60/70/80/90/100/110/120/130MM
 WEIGHT: 168G (110MM)



STOKER +35° STEM

ATB-922
 MATERIAL: AL6061
 HANDLEBAR Ø: 25.4/31.8MM
 STEERER Ø: 29.8/31.6MM
 ANGLE: +35°
 LENGTH: 190-230MM/215-255MM
 WEIGHT: 352G (190-230MM, Ø29.8/Ø25.4)



NEW

-17° DROP STEM

ATB-960
 MATERIAL: AL6061
 HANDLEBAR Ø: 31.8MM
 STEERER Ø: 28.6MM
 LENGTH: 70/80/90/100MM
 ANGLE: -17°
 WEIGHT: 158G (TBD)(80MM)



NEW

ECCENTRIC RING

CR-48/SRAM
 CR-49/SHIMANO
 MATERIAL: AL7075
 TYPE: 53/41, 51/36
 BCD: 130(53/41)(SRAM), 110(53/41, 51/36)
 WEIGHT: 187G (51/36, BCD 110)



FTP up 6%
Lower input 6%

- 6% Power 🟡
- 6% Cadence 🟡
- Pedaling Naturally Round
- Easier Transition From Bike To Running

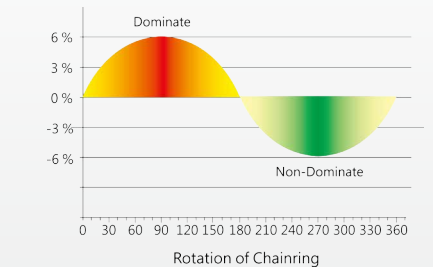
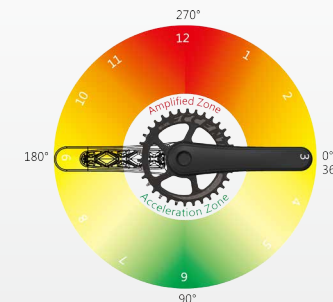

CARBON BOTTLE CAGE

BC-37
 MATERIAL: UD CARBON
 WEIGHT: 22G
 COLOR: RED/GRAY



SIDE-OPEN BOTTLE CAGE

BC-34
 MATERIAL: PLASTIC
 WEIGHT: 55G
 COLOR: RED/BLUE/GRAY



CONTROLTECH 700C ALLOY WHEELS

RIM-80
MATERIAL: AL6061
RIM TYPE: 700C CLINCHER
RIM WIDTH(OUTSIDE): 23MM
RIM WIDTH(INSIDE): 17MM
RIM DEPTH: 30MM
AXLE WIDTH (O.L.D.): F 100MM/ R 130MM
SPOKES: F 20H / R 24H
WEIGHT: 2,082G / PAIR
SHIMANO 11S OR CAMPY COMPATIBLE
TUBELESS READY

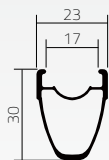

SIROCCO 3545 CL

RIM-79
MATERIAL: CARBON FIBER
RIM TYPE: 700C CLINCHER, ENDURO BEARINGS
RIM WIDTH(OUTSIDE): 23.8MM
RIM WIDTH(INSIDE): 16.8MM
RIM DEPTH: 35-45MM
TIRE WIDTH: 20-35C
AXLE WIDTH (O.L.D.) F: 100MM / R: 130MM
SPOKE: F 20H / R 24H 1:1
WEIGHT: 1550G / PAIR
SHIMANO 11S COMPATIBLE
UCI IMPACT TEST PASSED
TUBELESS READY

SIROCCO 3545 CL DISC

RIM-89-DB
MATERIAL: CARBON FIBER
RIM TYPE: 700C CLINCHER, ENDURO BEARINGS
RIM WIDTH(OUTSIDE): 23.8MM
RIM WIDTH(INSIDE): 16.8MM
RIM DEPTH: 35-45MM
TIRE WIDTH: 20-35C
AXLE WIDTH (O.L.D.) F: 100MM / R: 142MM
SPOKE: F 24H / R 24H 1:1
BRAKE INTERFACE: DISC CENTER LOCK
WEIGHT: 1580G / PAIR (TBD)
SHIMANO 11S COMPATIBLE
UCI IMPACT TEST PASSED
TUBELESS READY

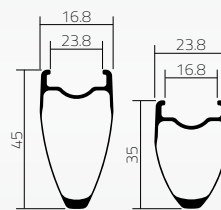

ACCESSORIES

CORK BAR TAPE

HT-07
MATERIAL: EVA
SIZE: 3CM X 185CM X 2.5MM
WEIGHT: 48G / PAIR
HIGH PERFORMANCE HANDLEBAR RIBBON
EVA FOAM MATERIAL REDUCES FATIGUE



NAPLAM DUO BAR TAPE

HT-11
MATERIAL: PU+SHOCKPROOF+SILICONE GEL
SIZE: 3 X 200CM X 2.5MM
WEIGHT: 153G / PAIR
ALUMINUM BAR PLUGS



NAPALM BAR TAPE

HT-12
MATERIAL: PU+SHOCKPROOF+SILICONE GEL
SIZE: 3CM X 200CM X 3.5MM
WEIGHT: 120G / PAIR
ALUMINUM BAR PLUGS



BAR PLUG
CAP-47
MATERIAL: AL6061
WEIGHT: 28G / PAIR



NEW

ATOM DUO BAR TAPE

HT-13
MATERIAL: PU+SHOCKPROOF+SILICONE GEL
SIZE: 3CM X 210CM X 2.5MM
WEIGHT: 70G / PAIR (TBD)



NEW

VULCANO BAR TAPE

HT-15
MATERIAL: PU+SHOCKPROOF+SILICONE GEL
SIZE: 3CM X 210CM X 2.5MM
WEIGHT: 70G / PAIR (TBD)



NEW

ATOM BAR TAPE

HT-14
MATERIAL: PU+SHOCKPROOF+SILICONE GEL
SIZE: 3CM X 210CM X 2.5MM
WEIGHT: 70G / PAIR (TBD)



CONTROL QR

QR-25
MATERIAL: TITANIUM
LENGTH: F 100-130 / R 100-135
WEIGHT: 70G / PAIR
MADE FOR ROAD RACING, SPORTIVE
RIDING AND CYCLOCROSS



RACE LIGHT SKEWERS

BT-06
LENGTH: 100-130, 100-135
FINISH: BLACK
WEIGHT: 26G
SPAN KEY
TITANIUM
ANTI-THEFT



DBH(DI2 BATTERY HOLDER)

AC-69
MATERIAL: RUBBER
SEATPOST Ø: 27.2/30.9/31.6MM
WEIGHT: 6G(Ø27.2MM)
HOLLOW DESIGN
USE FOR SHIMANO INTERNAL
BATTERY(SM-BTR2) SECURELY HIDE YOUR
DI2 BATTERY WITHIN YOUR SEATPOST



COMP CAP

CAP-28
MATERIAL: CARBON
STEERERS Ø: 23.3 - 25.4MM
WEIGHT: 29G



COMP ALLOY

CAP-29
MATERIAL: AL6061
STEERERS Ø: 23.3MM ~ 25.4MM
WEIGHT: 30G
CARBON STEERER FORK FRIENDLY,
INTERNAL EXPANDING SYSTEM



TESTY DOUBLE LOCK-ON
GP-12
MATERIAL: TESTY
LENGTH: 128MM
WEIGHT: 104G / PAIR(WITH CAP)
NARROW PROFILE WITH FLANGE
BLACK ALLOY LASER LOGO LOCK ON ENDS



SILICONE MTB GRIPS
GP-16
MATERIAL: SILICONE
LENGTH: 130MM
WEIGHT: 75G / PAIR
UV RESISTANT, RE-WRAPABLE, SHOCK ABSORBING
COMFORTABLE, EASY TO INSTALL, SUPER TACKY



CONTROL SEAT CLAMP
SC-74QR
MATERIAL: AL2014
INNERØ: 31.8/34.9MM
WEIGHT: 52G
STAINLESS STEEL AXLE
ALUMINUM CLAMP LEVER



SETTLE
SC-93
MATERIAL: AL7075
INNERØ: 31.8/34.9MM
WEIGHT: 14G(34.9MM)
HOLLOW DESIGN



ADAPT
SC-91
MATERIAL: AL6061
INNER Ø: 34.9/31.8MM
WEIGHT: 26G
HOLLOW DESIGN



TESTY SINGLE LOCK-ON
GP-13
MATERIAL: TESTY
LENGTH: 130MM
WEIGHT: 90G / PAIR
NARROW PROFILE WITH FLANGE
BLACK ALLOY LASER LOGO LOCK ON ENDS



MTB GRIP COLOR WITH HOLLOW DESIGN
GP-17
MATERIAL: PP+TPR
SIZE: Ø22.4 X 130MM
WEIGHT: 105G / PAIR



MTB GRIP COLOR
GP-18
MATERIAL: PP+TPR
SIZE: Ø22.4 X 130MM
WEIGHT: 105G / PAIR



CARBON SPACERS
HSS-13
MATERIAL: CARBON
STEERER Ø: 28.6MM
HEIGHT 5/10/15/20/25MM
WEIGHT: 1.4G(5MM)/2.8G(10MM)



FALCON STEM INTEGRATED SPACER
HSS-14
MATERIAL: AL6061
HEIGHT: 10MM
WEIGHT: 10G
FITS FALCON STEM



TERMINATOR MTB HANDLEBAR EXTENSION PLUG
AC-63
MATERIAL: AL6061
EXTERNAL: 22.2MM
INNER: 17.6-20.2MM
FINISH: BLACK
WEIGHT: 37G / PAIR



TERMINATOR ROAD HANDLEBAR EXTENSION PLUG
AC-62
MATERIAL: AL6061
EXTERNAL: 23.8MM
INNER Ø: 17.6-20.2MM
FINISH: BLACK
WEIGHT: 45G / PAIR



NEW HEADSET
HS-955
MATERIAL: AL6061
SIZE: UPPER 1-1/8", LOWER 1-1/2"
DIAMETER Ø: 28.6/44.5-51.8/39.8MM
STACK HEIGHT: 9.2+13=22.2MM
BEARINGS: SEALED CARTRIDGE
WEIGHT: 134.5G



NEW INTEGRATED SPLIT SPACER
HSS-11
MATERIAL: NYLON+GLASS FIBER
HEIGHT: 5/10MM
WEIGHT: 2.5G(5MM), 5G(10MM), 5G(TOP SPACER)
FOR RAS-88/RAS-101/ATB-960



NEW INTEGRATED SPLIT SPACER
HSS-18
MATERIAL: NYLON+GLASS FIBER
HEIGHT: 5/10MM
WEIGHT: 2G(5MM), 4G(10MM), 2G(TOP SPACER)
FOR RAS-92



MHS HEADSET
HS-952
MATERIAL: AL6061
SIZE: UPPER 1-1/8", LOWER 1-1/2"
DIAMETER Ø: 28.6/44-56/39.8MM
STACK HEIGHT: 7.3+3=10.3MM
BEARINGS: SEALED CARTRIDGE
WEIGHT: 163G



RHS HEADSET
HS-951
MATERIAL: AL6061
SIZE: UPPER 1-1/8", LOWER 1-1/2"
DIAMETER Ø: 28.6/41.8-52/39.8MM
STACK HEIGHT: 8.8+0.7=9.5MM
BEARINGS: SEALED CARTRIDGE
WEIGHT: 103G

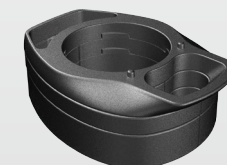

NEW INTEGRATED SPLIT SPACER
HSS-19
MATERIAL: NYLON+GLASS FIBER
HEIGHT: 5/10MM
WEIGHT: 5.3G(5MM), 10.5G(10MM), 5.7G(TOP SPACER) (TBD)
FOR LYNX ATB-958



Controltech Worldwid Distributors

Area	Country	Distributor Company Name	Address	Tel. No.	Web
Asia	China	KINGFORCE	No. 155 Baiyundu Rd., Ludu Town, Taicang City, Jiangsu, China	+86-512-5328-9080	www.bhbikeschina.com
Asia	Hong Kong	Kung Sheung Cycle Co.	39D Battery Street, Jordan, Kln., H.K	+852-2385-2080	www.kungsheungcycle-part.com.hk
Asia	Taiwan	Dalux Int. Co. Ltd	No. 12, Ln. 538, Sec. 1 Yuandong Road, Yuanlin City, Changhua, Taiwan	+886-4-8353575	www.krex.com.tw
Asia	Taiwan	Dacaltech Co. Ltd.	12F., No. 325, Renyi St., Sanchong Dist., New Taipei City 241, Taiwan (R.O.C.)	+886-2-28572687	www.dacal.bike
Asia	Singapore	New Era Cycle	#01-04, 14 Arumugam Road, LTC Building C, 新加坡 409959	+65 6100 8645	neweracycle.com
Asia	Thailand	AMORN ELECTRONIC CENTER SPARE PART CO., LTD.	17/18-19 Moo 6, Bangkratuek, Amphur Sampran Nakornprathom 73210, Thailand	+66-2-4821320	www.amornbicycle.com
Asia	Indonesia	Bagus bike	Komp. Ruko sektor 7 blok rn 61 tangerang 15310, Indonesia	+62-21-5371115	www.bagusbike.com
Asia	Philippines	Bike One Cycle Mart	Unit 9 Pasda Bldg. Araneta Ave. Cor P. Florentino st Brgy. Sto Domingo Quezon City, Philippines	+63-2516-3553	www.bikeonecycle.com
Asia	Japan	Magic One CO. LTD.	〒593-8322 大阪府堺市西区津久野町3丁2-4	+81 72-263-5135	mgc01.com
Asia	Japan	Dragon Bike	東京都千代田区九段南1-5-6		dragonbike.net
Asia	India	Bicycle Paradise (B. S. Enterprises)	SR-8, Nursery Circle, Vaishali Nagar, Jaipur-302021	+91-9649977772	bicycleparadise.jaipur@gmail.com
Asia	Vietnam	Bike Life	83 Phạm Thái Bường, Tân Phong, Quận 7, Hồ Chí Minh	+84 28 5412 4217	www.facebook.com/bikelife.com.vn
Asia	Malaysia	Huan Schen Sdn. Bhd.	No. 12, Jalan Tiaj 2/5, Taman Industri Alam Jaya, Bukit Chera, Selangor, 42300 Bandar Puncak Alam	+60 3-6038 6788	www.facebook.com/Huan-SchenSB
Asia	Qatar	Carbon Wheels Qatar	Shop 141 Qanat Quartier, The Pearl (Opposite the Kempinski Roundabout)	+974 4441 9048	carbonwheels.qa
Asia	Cambodia	Flying Bikes 2	No. 131 BEO, Pasteur (St51), 12210 Phnom Penh, Cambodia	+855 012727717	flyingbikes2.com
Asia	Israel	Ride 2 The Edge	Professor yuval Ne'eman Tel Aviv, Israel 6967158	+972 50-888-1996	r2te.com
America	Brazil	Soul Cycles	Rodovia Jorge Lacerda, 1010 - Galpão 3, Bairro Espinheiros - Itajaí - SC - Brasil CEP 88317-100	+47 3404-4100	www.soulcycles.com.br
America	Chile	MKR IMPORTS	San Diego #1184 Santiago - Chile	+56 22 555 5743	www.mkr.cl
America	Mexico	BIKE STOP S.A. DE C.V.	Calle Isidro Félix de Espinosa #8, Cimatarío, 76030 Santiago de Querétaro, Qro.	+52 442 224 1089	bikestop.com.mx
America	Puerto Rico And Caribbean Area	Pro Cycling Center	St. #2, KM 123, Caimital Alto, Aguadilla PR 00603	+1 787-705-7242	www.sperosportswear.com
America	Colombia	BIKE SUPPLY S.A.S.	Calle 23 # 68b-32 Bogota, Colombia	+57 3007319582	
Europe	ITALY	Velo 04 S.r.l.	Via Vallazze, 61 20131 Milano (MI)	+39 3756209004	www.velo-04.com/it
Europe	ITALY	Kuota Srl	Via Enrico Mattei 2 20852 Villasanta (MB) Italia	+39 393-05595	www.kuotacycle.it
Europe	GREAT BRITAIN (UNITED KINGDOM)	BOB ELLIOT & CO LTD	Unit C4 Binary Court Matrix Park Western Avenue Buckshaw Village Chorley PR7 7NB	+44 1257 248480	www.bob-elliott.co.uk
Europe	CZECH REPUBLIC & SLOVAKIA	KCK Cyklosport	Bartošova 348 765 02 Otrokovice - Kvitkovice	+420 577 217 520	www.kckcyklosport.cz
Europe	UKRAINE	Leader Bike	03037 ,Kyiv, Ukraine avn.Lobanovskogo 12	+380442498350	leaderonline.com.ua
Europe	GERMANY & THE BENELUX AREA	Tehava	Tomeikerweg 31 6161RB Geleen NLD	+31-0-46-4752100	www.tehava.com/en-us
Europe	Poland	Merida Polska SP. Z O.O.	UL.M.C. Skłodowskiej 35. 41-800 Zabrze, Poland	+48-32-273-3232	www.rowerymerida.pl
Europe	SPAIN & ANDORRA	Bike Difusion	Arkatxa Kalea, 1, 01006 Vitoria-Gasteiz, Araba, Spain	+34 945 15 82 88	www.bikedifusion.com
Africa	SOUTH AFRICA	Positive Sports Solutions (Pty) Ltd	2 Regency Drive, Route 21 Office Park, Irene, Centurion 0157, Republic of South Africa	+27 076 423 3416	positivesportssolutions.co.za
Australia	AUSTRALIA	LINKSPORTS	21 North Street Leichhardt NSW 2040 Australia	+61 02 9560 7841	www.linksports.com.au

DISTRIBUTORS

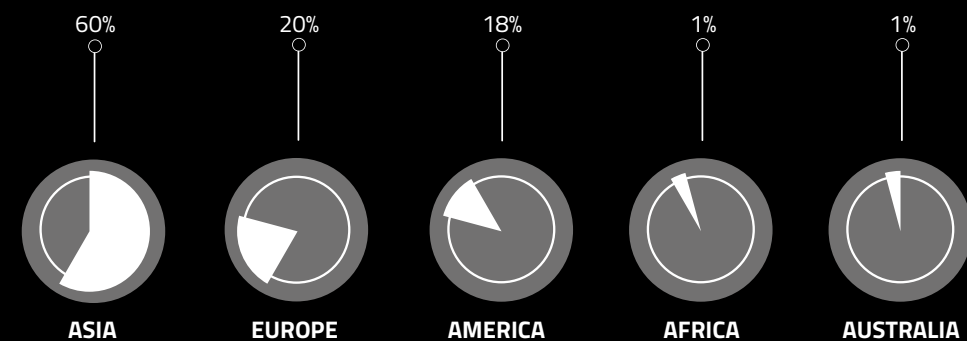

DISCONTINUED PRODUCT

MODEL NAME	ITEM NUMBER	SPECIFICATIONS	NOTES
TUX ROAD BAR	RA-476	ALL SIZE	DISCONTINUED
EXL GRAVEL BAR	RA-524	ALL SIZE	DISCONTINUED
EXL ROAD BAR	RA-510	ALL SIZE	DISCONTINUED
TUX OFFSET SEATPOST	SP-1340	ALL SIZE	DISCONTINUED
TUX 10MM OFFSET SEATPOST	SP-1440	ALL SIZE	DISCONTINUED
TUX ZERO OFFSET SEATPOST	SP-1210	ALL SIZE	DISCONTINUED
TUX OMM OFFSET SEATPOST	SP-1430	ALL SIZE	DISCONTINUED
EXL LIGHT CARBON SEATPOST	SP-1520	ALL SIZE	DISCONTINUED
AFFILADO	SP-1350	ALL SIZE	DISCONTINUED
TUX R45 TU	RIM-63	ALL SIZE	DISCONTINUED
TUX R45 TU DISC	RIM-63DISC	ALL SIZE	DISCONTINUED
TUX R45 CL	RIM-64	ALL SIZE	DISCONTINUED
TUX R45 CL DISC	RIM-64DISC	ALL SIZE	DISCONTINUED
AERO COCKPIT CARBON	TTH-09CB	ALL SIZE	DISCONTINUED
AERO COCKPIT AL	TTH-09AL	ALL SIZE	DISCONTINUED
AERO TT AL	TTH-11	ALL SIZE	DISCONTINUED
AERO COCKPIT PLUS	TTH-12	ALL SIZE	DISCONTINUED
BURST	PD-03	ALL SIZE	DISCONTINUED
SILICONE BAR TAPE	HT-08	ALL SIZE	DISCONTINUED
CONTROL QUICK RELEASE	QR-25	ALL SIZE	DISCONTINUED
FALCON SPEED SADDLE	SD-22	ALL SIZE	DISCONTINUED

TECHNOLOGY

It's easy to make a simple product look simple – but it takes genius to make a complex one elegant. That's where Controltech excels. Components such as handlebars, seatposts and even wheels may look simple, but if you want high performance, you inevitably introduce a great deal of complexity under the skin and behind the scenes.

At Controltech, we break that down to four key elements. First, there's the ideas stage, but even our Research & Development is inextricably linked with a hard understanding of materials and manufacturing. Our innovation and engineering overlaps real-world riding with pure science and good engineering – it's the only way to work out not just what's possible, but what's desirable.

Next, we look at aerodynamics, using a mix of Computational Fluid Dynamics (CFD) and real-world performance testing. It's a vital area for road and especially triathlon products, and our longstanding expertise in carbon fiber and high-precision alloy milling mean Controltech's use of shaping is second to none.

We never restrict ourselves to one material, even within a single component. Each part of every piece is carefully specified for its particular properties: the strength of steel, the low density of aluminum, the exotic hardness of titanium, or just about any aspect of the many different types of carbon our experts work with. With Controltech's hard-won knowledge, carbon can be optimized in any number of areas, styles and directions at once.

Last – and least, in one very specific sense – is weight. Low weight is vital, yet when you put this much effort into the first three areas, it almost takes care of itself. Careful design, the correct choice and sourcing of materials and beautifully minimalistic shaping combine with advanced manufacturing techniques – such as multiple tube wall thicknesses, intense CNC machining and complex one-piece moulding – to create very low weights without structural compromise. Controltech builds strong, it builds light, and it builds advanced.





CONTROL
TECH

www.controltechbikes.com